

Emergency box

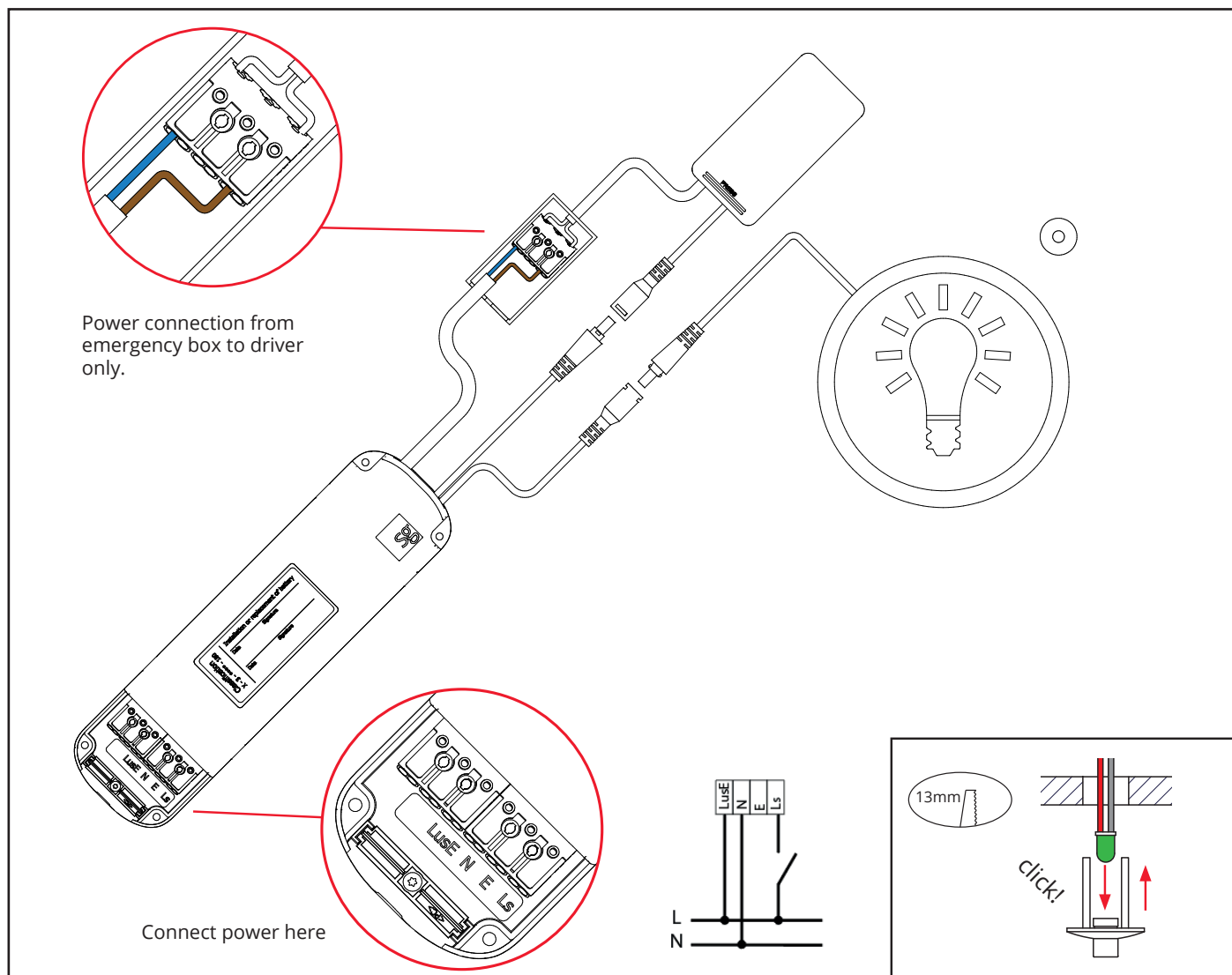

220-240V, 50/60Hz, Self-test



DK: I Frankrig og Danmark er en permanent forbindelse påkrævet af sikkerhedsbelysningsforskrifterne! For Danmark og Frankrig er det nødvendigt at sikre twistforbindelsen ved at montere løsning med ekstra koblingslås - brug følgende produkt som skal bestilles separat: 8241000276

FR: En France et au Danemark, une connexion permanente est exigée par la réglementation pour l'éclairage de sécurité !
Pour le Danemark et la France, il est indispensable de sécuriser la connexion torsadée en équipant la solution d'un verrou de connexion supplémentaire - utilisez le produit suivant, qui doit être commandé séparément : 8241000276

NORWAY

SG Armaturen AS

Skytterheia 25
N-4790 Lillesand

Tel: +47 37 50 03 00
firmapost@sg-as.no
www.sg-as.no

SWEDEN

SG Armaturen AB

Tel: +46 31 81 71 10
info@sg-ab.se
www.sg-ab.se

FINLAND

SG Armaturen Oy
Tel: +358 02 07 30 39 60
info@sg-oy.fi
www.sg-oy.fi

DENMARK

SG Armaturen A/S
Tel: +45 70 70 72 13
info@sg-as.dk
www.sg-as.dk

UNITED KINGDOM

SG Lighting LTD
Tel: +47 37 50 03 00
info@sglighting.co.uk
www.sglighting.co.uk

FRANCE

SG Lighting SA/NV
Tel: +33(0) 4 94 93 00 00
info.france@sglighting.fr
www.sglighting.net

BENELUX

SG Lighting SA/NV
Tel: +32(0) 15 20 72 71
info.benelux@sglighting.net
www.sglighting.net

GERMANY

SG Leuchten GmbH
Tel: +49 40 23 99 44 59
info@sg-leuchten.de
www.sg-leuchten.de

INTERNATIONAL

SG Lighting Co Ltd.
Tel: +86 769 88 49 20 88
cindy@sgdgc.com
www.sg-as.com

3: Replaceable control gear by a professional

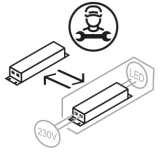

NO: Kan kun installeres og vedlikeholdes av en registrert installasjonsvirksomhet.
DK: Må kun installeres og vedligeholdes af uddannet elektriker.
SE: Skall installeras och underhållas av behörig elektriker.
EN: Only to be installed and maintained by an authorized electrician.
FR: Doit être installé et maintenu par un électricien qualifié.
NL: Mag alleen geïnstalleerd en onderhouden worden door een bevoegde electricien.
DE: Dieses Produkt darf nur durch autorisiertes Personal (z.B. Elektro-Installateur) angeschlossen, in Betrieb genommen und gewartet werden.
FI: Asentaa ja huoltaa saa vain valtuutettu sähköasentaja

NO: Skru av strømmen før montering.
DK: Sluk for strømmen inden montering.
SE: Stäng av strømmen innan montering.
EN: Turn off power before installing.
FR: Couper le courant avant l'installation.
NL: Stroom uitschakelen voor u het toestel installeert
DE: Vor Installationsarbeiten den Strom abschalten.
FI: Sammuta virta ennen kytkemistä

Installation/Replacement of battery
 Date _____ Sign. _____
 dd.mm.yy _____ Signature _____
 Date _____ Sign. _____

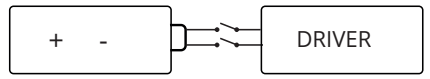
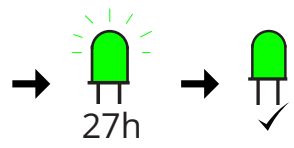
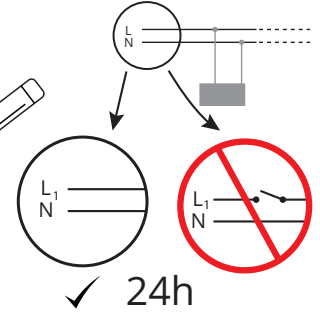

or:

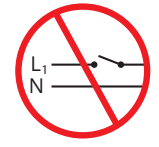
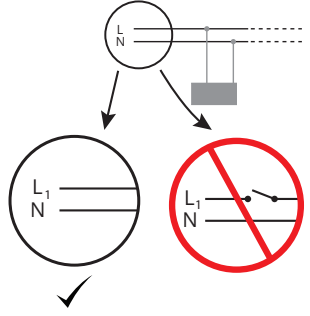

MAX 2 MONTHS

		System OK/main operation mode
	2 sec	Duration test/comissioning
	0,5 sec	Function test
		LED luminaire fault
	2 sec	Battery/test failure
	0,5 sec	Battery charging failure

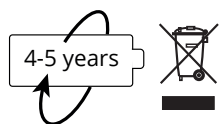
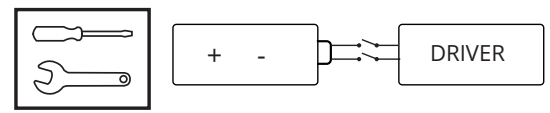

Please also consider local requirements.

