

<b>DK</b>	Monteringsvejledning
<b>UK</b>	Mounting Instructions
<b>D</b>	Montageanleitung
<b>FIN</b>	Asennusohje
<b>E</b>	Herradura instrucciones
<b>S</b>	Montageanvisningarna

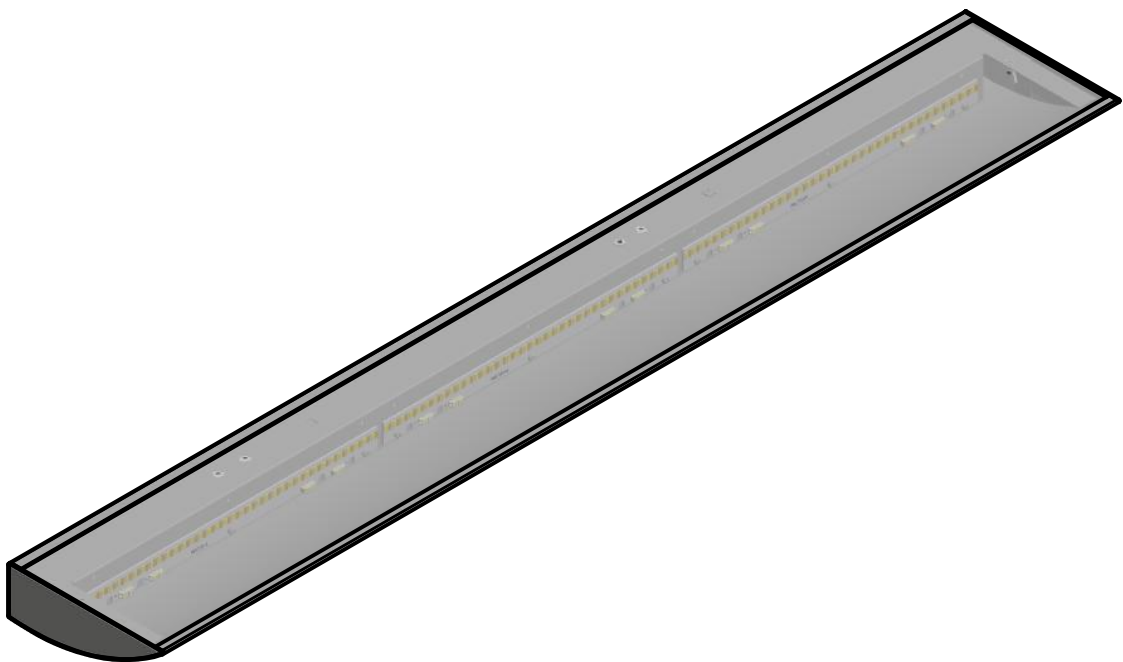

# Dimensions

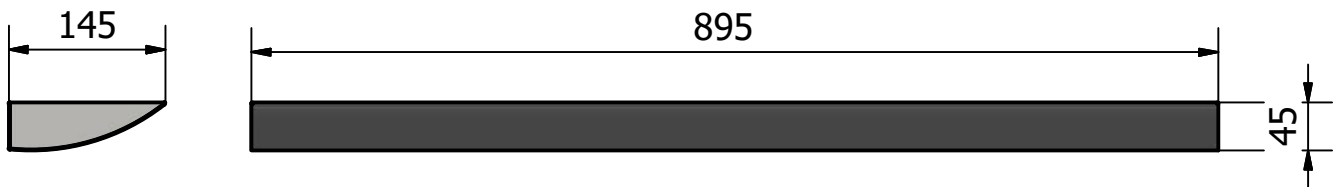

## Content

## Data

AC 220-240V / 50 Hz

LED

IP 20

Cl. I

6kg



# Mounting

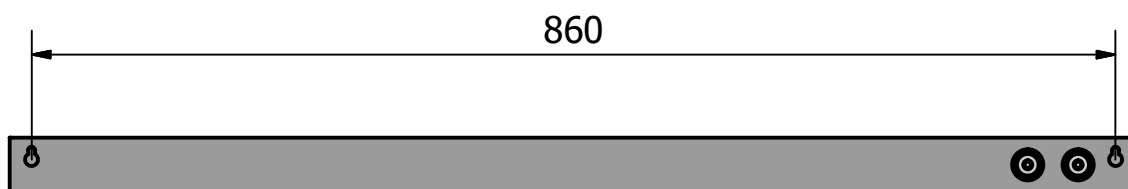
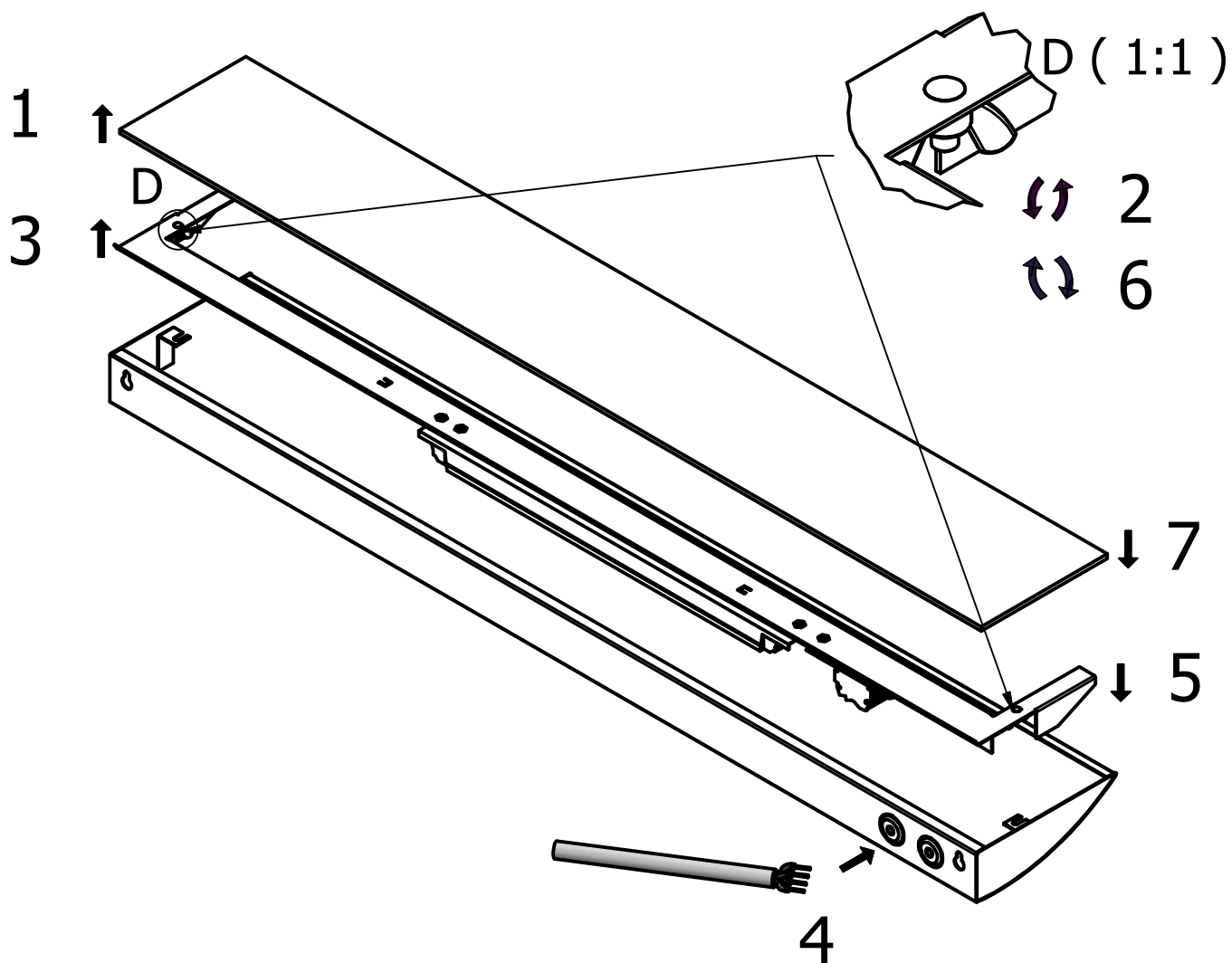

# Service and disposal of luminaires

Acc. to EU regulation 245/2009

## Instruction for luminaire service

Replace aged or failed lamp/LED	Switch Off	Open luminaire	Remove old lamp/LED	Fit new lamp/LED	Refit optic

LED



### Preventing electrostatic damage

A discharge of static electricity may damage LED components.

Connect a wristband to the housing by a ground cord.

Avoid touching LED with bare hands.

## Instruction for end of life and components disposal - For emergency lighting

Switch Off	Remove lamp for disposal (not for LED)	Remove battery for disposal	Remove luminaire for disposal	Dispatch materials to recycling

## Instruction for end of life and components disposal

Switch Off	Remove lamp for disposal (not for LED)	Remove luminaire for disposal	Dispatch materials for recycling

**DK/S/N:** Produktet skal efter produktets levetid afleveres hos affaldsforarbejder - Kontakt din lokale leverandør eller leverandørens hjemmeside for yderligere information.

**UK:** When the product reaches the end of its service life; it must be delivered to a waste disposal facility. Contact your local supplier or visit their website for more information.

**D:** Das Produkt muss nach dessen Lebenszeit bei entsprechenden Abfallensorgungsstellen entsorgt werden. Für weitere Fragen kontaktieren Sie Ihren lokalen Lieferanten oder besuchen die Homepage des Lieferanten.

**FIN:** Tuote on toimitettava elinikänsä päätyttyä elektroniikkaromun kierrätykseen. Tarkempia tietoja saatte ottamalla yhteyttä toimittajaan tai toimittajan internet-sivuilta.

**E:** Una vez que el producto haya alcanzado el final de vida, debe ser eliminado en los correspondientes puntos de reciclaje. Para más información rogamos contacten con su proveedor local o consulten la página web del mismo.

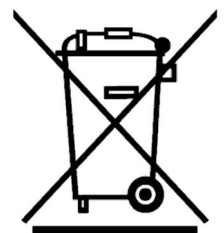

# Label

	DK / S / N	D	GB	FIN	E
<b>Mounting</b>	Se etiket på armatur for korrekt montering	Siehe Etikett an der Leuchte für den korrekten Anschluss der Leuchte.	See label on fixture for correct mounting	Ks. valaisimen arvokilvestä oikea asennustapa	Ver etiqueta en la luminaria para un montaje correcto de la misma
<b>Lus</b>	- Direkte fase - Nødløys fase - Switch&Dim fase - DALI fase	- Konstante Phase - Notlicht Phase - Switch&dim Phase - DALI Phase	- Live Unswitch - Emergency Live - Switch&Dim Live - DALI Live	- Suora vaihe - Turvavalaistus vaihe - Switch&Dim vaihe - DALI vaihe	- Fase directa constante - Fase emergencia - Fase Switch&Dim - Fase DALI
<b>LusE</b>	- Nødløys fase	- Konstante Notlicht Phase	- Emergency Live Unswitch	- Turvavalaistus vaihe	- Fase emergencia constante
<b>Ls</b>	- Tændledning on/off - Tændledning Switch&Dim	- Geschaltete Phase - Geschaltete Phase für Switch&Dim	- Live Switch - Live Switch Switch&Dim	- Vaihe on/off - Switch&Dim vaihe	- Fase conectada on/off - Fase conectada para conexión & regulación
<b>Ls1 / Ls2</b>	- Tænding 1 - Tænding 2 - Tænding 1 Switch&Dim  - Tænding 2 Switch&Dim	- Geschaltete Phase 1 - Geschaltete Phase 2 - Geschaltete Phase 1 für Switch&Dim - Geschaltete Phase 2 für Switch&Dim	- Live Switch 1 - Live Switch 2 - Live Switch 1 Switch&Dim - Live Switch 2 Switch&Dim	- Vaihe kytkin 1 - Vaihe kytkin 2 - Switch&Dim vaihe kytkin 1 - Switch&Dim vaihe kytkin 2	- Fase conectada 1 - Fase conectada 2 - Fase conectada 1 para Switch&Dim - Fase conectada 2 para Switch&Dim
<b>N</b>	- Nulleader	- Null	- Neutral	- Nolla	- Neutro
<b>DA</b>	- DALI	- DALI	- DALI	- DALI	- DALI
<b>D1 / D2</b>	- DSI signal ( Tridonic )	- DSI Signal (Tridonic)	- DSI signal ( Tridonic )	- DSI ohjaus ( Tridonic )	- Señal DSI (Tridonic)
<b>DD</b>	- DigiDim ( Helvar )	- DigiDim (Helvar)	- DigiDim ( Helvar )	- DigiDim ( Helvar )	- DigiDim ( Helvar )

## Instruction for luminaire cleaning

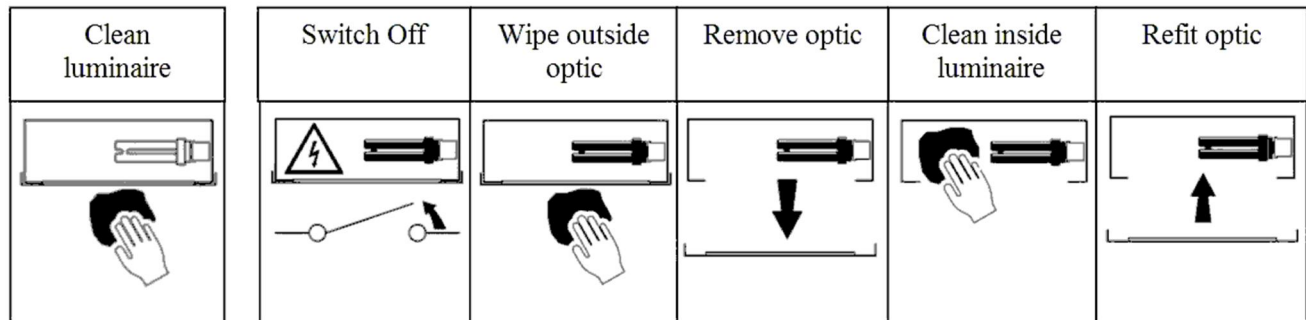

### Cleaning:

Most of the items can be cleaned with a soft liquid soap and water with a maximum temperature of 60°C. The use of washing liquids containing abrasive or solvents is not advised as it causes damage to the surface.

### Guideline for Cleaning of Material:

It is important to clean the luminaire in the right way to avoid damage.

Powder coated sheet steel	Damp, lint-free cloth, soft liquid soap.
Reflector in aluminium	Dry, lint-free cloth.
Cross blade louvre in aluminium	Dry, lint-free cloth.
Cross blade louvre in sheet steel	Damp, lint-free cloth, soft liquid soap.
Polycarbonate cover	Clear water of maximum 60°C
Acrylic cover	Clear water of maximum 60°C
Glass cover	Clear water of maximum 60°C
ABS plastics	Clear water of maximum 60°C
ASA plastics	Clear water of maximum 60°C

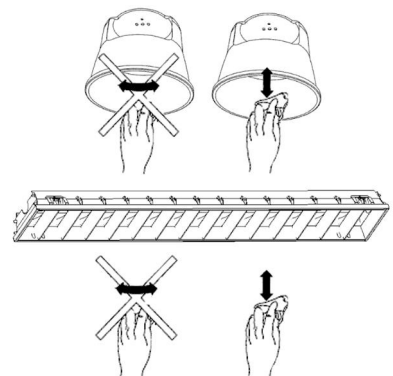

### Cleaning Aluminum Reflectors and Double Parabolic Louvres

Before cleaning, gently dust to remove scratch-inducing particulate matter.

### To clean, choose one of the following methods:

Rub gently with a clean, dry lint-free cloth (cheesecloth is excellent). This often works on "normal" stains, such as spots or greasy fingerprints. Avoid hard brushing.

Dampen a clean, dry, lint-free cloth with Isopropyl (rubbing) alcohol. Rub gently on louvre. Louvre or reflector will streak as alcohol is applied, but streaks disappear as alcohol evaporates.

Use an aluminium reflector cleaner.

Use of gloves is recommended when handling to prevent fingerprint marks. Some people have a high acidity in their perspiration, causing fingerprints to etch into anodised aluminium material. There is no method to remove fingerprints of this type.

**Note: Do not use these methods on polystyrene or acrylic louvres.**

### Cleaning Interval:

Lighting fixtures should be cleaned periodically, when dirty and in connection with the lamp change - min. once a year.

# Warranty information

**DK/S/N:** Dette armatur må kun bruges til belysning og skal installeres i overensstemmelse med gældende installationsbestemmelser. Enhver anden brug eller installation vil betragtes som "ikke i overensstemmelse med montagevejledning".

**UK:** The lamp is used exclusively for lighting and is to be installed in accordance with the national installation regulations. Any other use or installation is regarded as "not according to instructions".

**D:** Die Leuchte dient ausschließlich der Beleuchtung und ist entsprechend den nationalen Errichtungsbestimmungen zu installieren. Eine andere Nutzung oder ein anderer Einbau gilt als „nicht bestimmungsgemäß“.

**FIN:** Valaisin on tarkoitettu ainoastaan valaistuskäyttöön, ja se on asennettava kansallisten määräysten mukaan. Muu käyttö tai muu asennus katsotaan sopimuksenvastaiseksi käytöksi.

**E:** La Lámpara está destinada exclusivamente a la iluminación y debe ser instalada de acuerdo con las pertinentes normas nacionales. Cualquier otro uso o instalación no se considerará "previsto por la norma".

**DK/S/N:** Installation og service må kun udføres af autoriseret personale.

**UK:** Installation and service may only be carried out by authorized specialists.

**D:** Die Montage und Service darf nur von autorisiertem Fachpersonal durchgeführt werden.

**FIN:** Asennuksen ja huolto saa tehdä vain auktorisoitu ammattihenkilöstö.

**E:** El montaje y el servicio deben ser realizado por personal especializado autorizado.

**DK/S/N:** Isolation/Megger Test. Kortslut Fase (L) & nul (N). Test mellem L/N og jord. Test med max 500 V DC. Se yderligere EN-61557 - Electrical safety standard.

Note: Isolationstest mellem fase/jord, nul/jord eller fase/nul kan ødelægge HF enheden.

**UK:** Isolation/Megger Test. During measurement, connect Live and Neutral together and measure between Live/Neutral and Earth.

Measure with max 500 V DC. See also EN-61557 - 'Electrical safety standard'

Notice: Isolationstest between Live/Earth, Neutral/Earth or Live/Neutral will damage the HF control gear.

**D:** Isolationstest. Zur Messung die Phase und den Nullleiter miteinander verbinden und zwischen Phase/Null und Schutzleiter messen.

Messung mit max. 500V DC. Siehe auch EN-61557 - "Elektrischer Sicherheitsstandard"

Merke: Isolationstest zwischen Phase/Schutzleiter, Nullleiter/Schutzleiter oder Phase/Nullleiter kann das Elektronische Vorschaltgerät beschädigen.

**FIN:** Eristysvastusmittaus. Varmista jännitteettömyys !

Kytke vaihe (L) ja nolla (N) yhteen ja mittaa eristysvastus tämän yhdistelmän ja suojavaan (KeVi) väliltä.

Sallittu mittausjännite max 500 VDC. Katso tarvittaessa EN-61557 - Electrical Safety Standard

Huom! Muut mittaukset vaurioittavat liitäntälaitteen elektroniikkaa.

**E:** Test de aislamiento. Para la medición unir la fase y conductor neutro y medir entre fase/neutro y toma de tierra. Medición con max. 500V DC. Ver también EN-61557 - "Estándar de la Seguridad Eléctrica"

Nota: Test de aislamiento entre fase/toma de tierra, conductor neutro/toma de tierra o fase/conductor neutro puede dañar la reactancia electrónica.

# Notes

# Notes