

Piano, Canto, Tardo

CE UK CA IP65

220-240V, 50/60Hz

0,5 - 1,0 mm² 8 mm

1,5 - 2,5 mm² 12 mm

Dipswitch

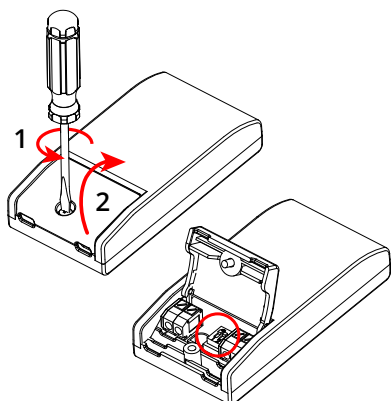

	Standard					
	ON	ON	ON	ON	ON	ON
	1 2 3	1 2 3	1 2 3	1 2 3	1 2 3	1 2 3

mA	200	250	300	350	400	450
lm	63%	75%	86%	100%	114%	128%

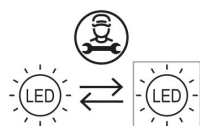

NO: Kan kun installeres og vedlikeholdes av en registrert installasjonsvirksomhet.
DK: Må kun installeres og vedlikeholdes af uddannet elektriker.
SE: Skall installeras och underhållas av behörig elektriker.
EN: Only to be installed and maintained by an authorized electrician.
FR: Doit être installé et maintenu par un électricien qualifié.
NL: Mag alleen geïnstalleerd en onderhouden worden door een bevoegde elektricien.
DE: Dieses Produkt darf nur durch autorisiertes Personal (z.B. Elektro-Installateur) angeschlossen, in Betrieb genommen und gewartet werden.
FI: Asentaa ja huolttaa saa vain valtuutettu sähköasentaja

NO: Skru av strømmen før montering.
DK: Sluk for strømmen inden montering.
SE: Stäng av strømmen innan montering.
EN: Turn off power before installing.
FR: Couper le courant avant l'installation.
NL: Stroom uitschakelen voor u het toestel installeert.
DE: Vor Installationsarbeiten den Strom abschalten.
FI: Sammuta virta ennen kytkemistä

NORWAY
SG Armaturen AS

Skytterheia 25
N-4790 Lillesand

Tel: +47 37 50 03 00
firmapost@sg-as.no
www.sg-as.no

SWEDEN

SG Armaturen AB
Tel: +46 31 81 71 10
info@sg-ab.se
www.sg-ab.se

FINLAND

SG Armaturen Oy
Tel: +358 02 07 30 39 60
info@sg-oy.fi
www.sg-oy.fi

DENMARK

SG Armaturen A/S
Tel: +45 70 70 72 13
info@sg-as.dk
www.sg-as.dk

UNITED KINGDOM

SG Lighting LTD
Tel: +47 37 50 03 00
info@sglighting.co.uk
www.sglighting.co.uk

FRANCE

SG Lighting SA/NV
Tel: +33(0) 4 94 93 00 00
info.france@sglighting.fr
www.sglighting.net

BENELUX

SG Lighting SA/NV
Tel: +32(0) 15 20 72 71
info.benelux@sglighting.net
www.sglighting.net

GERMANY

SG Leuchten GmbH
Tel: +49 40 23 99 44 59
info@sg-leuchten.de
www.sg-leuchten.de

INTERNATIONAL

SG Lighting Co Ltd.
Tel: +86 769 88 49 20 88
cindy@sgdgc.com
www.sg-as.com

HC009S sensor



230V, 50Hz

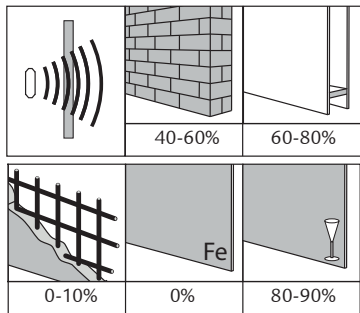
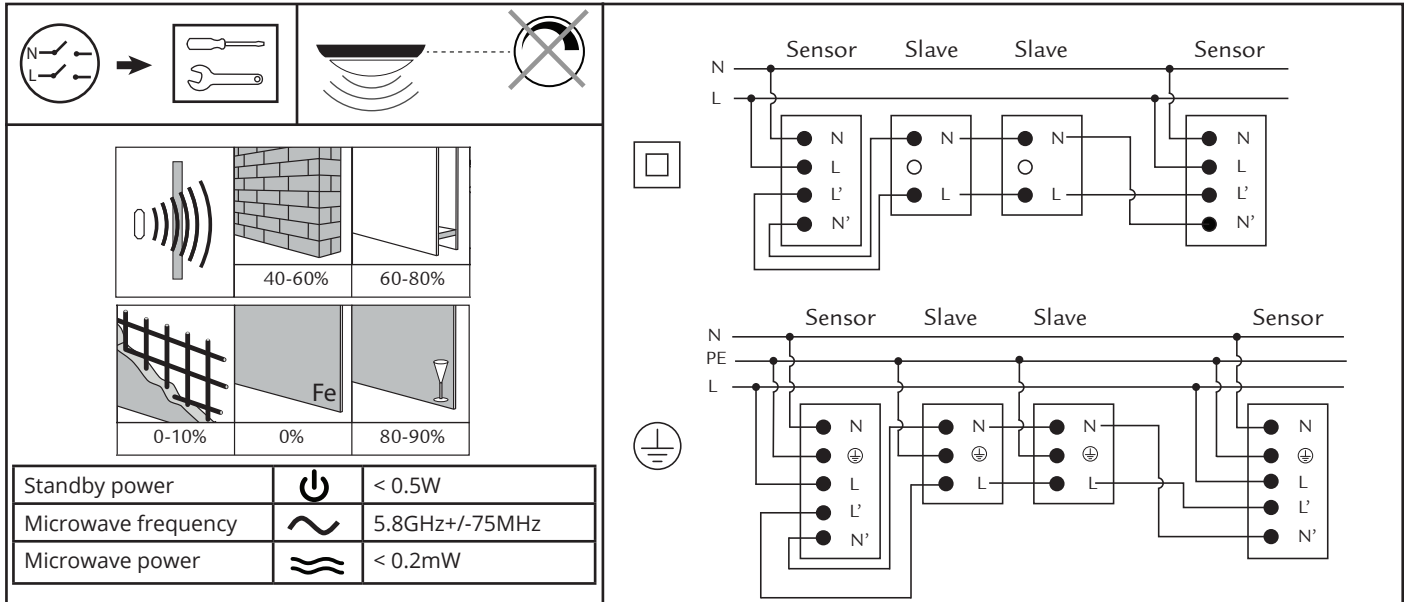

Standby power		< 0.5W
Microwave frequency		5.8GHz+/-75MHz
Microwave power		< 0.2mW

	1	2	3	
I	●	●	●	100%
II	○	●	●	75%
III	●	○	●	50%
IV	●	●	○	25%
V	○	○	○	10%

	1	2	3	4	
I	●	●	●	●	5s
II	○	●	●	●	30s
III	●	○	●	●	1min
IV	●	●	○	●	5min
V	●	●	●	○	15min
VI	○	○	○	○	30min

	1	2	3	4	
I	●	●	●	●	2 Lux
II	○	●	●	●	5 Lux
III	●	○	●	●	10 Lux
IV	●	●	○	●	30 Lux
V	●	●	●	○	50 Lux
VI	○	○	○	○	Disable

Max 400W

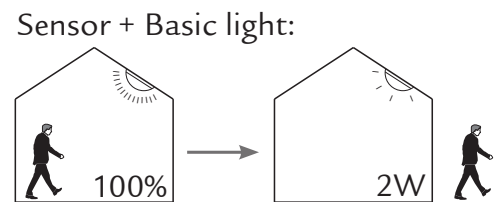
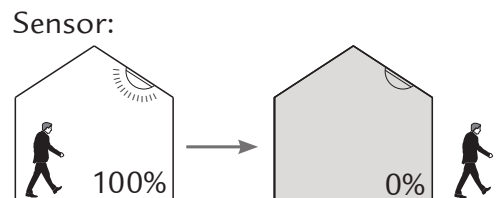
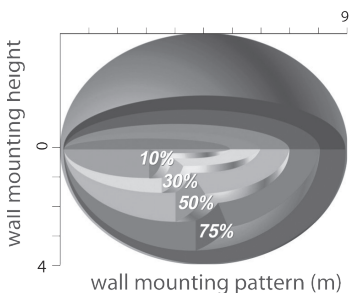
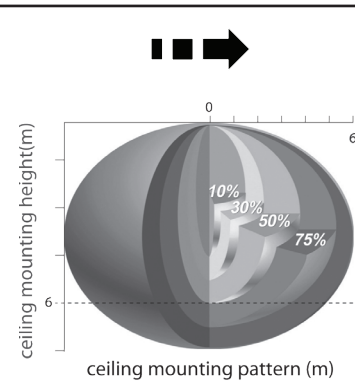

NORWAY SG Armaturen AS
Skytterheia 25
N-4790 Lillesand
Tel: +47 37 50 03 00
firmapost@sg-as.no
www.sg-as.no

SWEDEN SG Armaturen AB
Tel: +46 31 81 71 10
info@sg-ab.se
www.sg-ab.se

FRANCE SG Lighting SA/NV
Tel: +33(0) 4 94 93 00 00
info.france@sglighting.fr
www.sglighting.net

GERMANY SG Leuchten GmbH
Tel: +49 40 23 99 44 59
info@sg-leuchten.de
www.sg-leuchten.de

FINLAND SG Armaturen Oy
info@sg-oy.fi
www.sg-oy.fi

DENMARK SG Armaturen A/S
Tel: +45 70 70 72 13
info@sg-as.dk
www.sg-as.dk

BENELUX SG Lighting SA/NV
Tel: +32(0) 15 20 72 71
info.benelux@sglighting.net
www.sglighting.net

INTERNATIONAL SG Lighting Co Ltd.
Tel: +86 769 88 49 20 88
cindy@sgdgc.com
www.sg-as.com