

# Flom

CE UK CA IP65

220-240V, 50/60Hz



	Height	Width	Maximum projected area	Weight
Flom Mini	95mm	120mm	114cm <sup>2</sup>	0,54 kg
Flom Mini Sensor	95mm	120mm	114cm <sup>2</sup>	0,58 kg
Flom Midi	130mm	160mm	208cm <sup>2</sup>	0,91 kg
Flom Midi Sensor	130mm	160mm	208cm <sup>2</sup>	0,93 kg
Flom Maxi	160mm	200mm	320 cm <sup>2</sup>	1,47 kg
Flom Maxi Sensor	160mm	200mm	320 cm <sup>2</sup>	1,51 kg

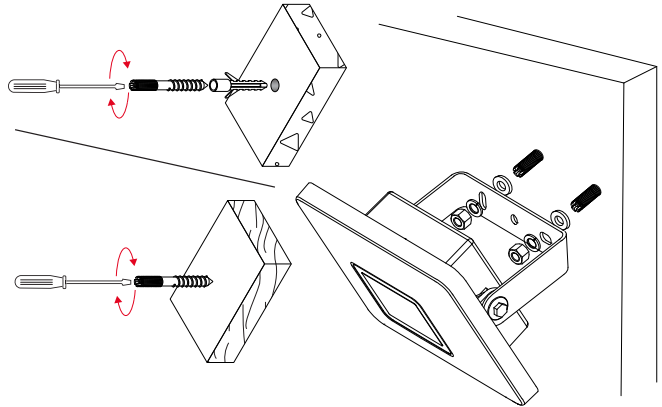
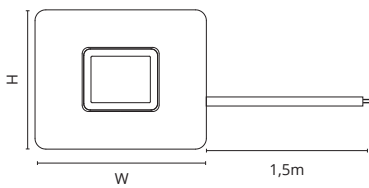

## Flom Mini

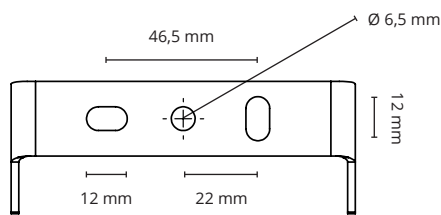

## Flom Midi

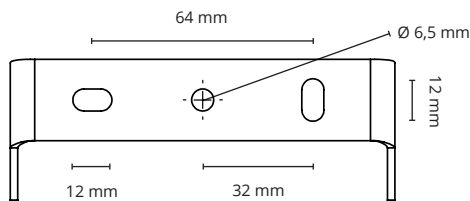

## Flom Maxi

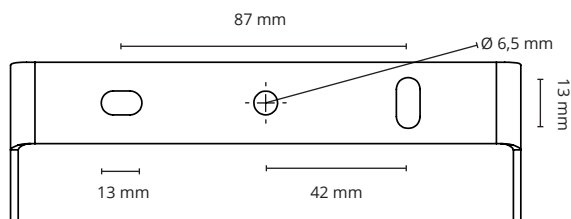

### 7: Non-replaceable light source



**NO:** Kan kun installeres og vedlikeholdes av en registrert installasjonsvirksomhet.  
**DK:** Må kun installeres og vedlikeholdes af uddannet elektriker.  
**SE:** Skall installeras och underhållas av behörig elektriker.  
**EN:** Only to be installed and maintained by an authorized electrician.

### 3: Replaceable control gear by a professional



**FR:** Doit être installé et maintenu par un électricien qualifié.  
**NL:** Mag alleen geïnstalleerd en onderhouden worden door een bevoegde elektricien.  
**DE:** Dieses Produkt darf nur durch autorisiertes Personal (z.B. Elektro-Installateur) angeschlossen, in Betrieb genommen und gewartet werden.  
**FI:** Asentaa ja huoltaa saa vain valtuutettu sähköasentaja



**NO:** Skru av strømmen før montering.  
**DK:** Sluk for strømmen inden montering.  
**SE:** Stäng av strømmen innan montering.  
**EN:** Turn off power before installing.  
**FR:** Couper le courant avant l'installation.  
**NL:** Stroom uitschakelen voor u het toestel installeert.  
**DE:** Vor Installationsarbeiten den Strom abschalten.  
**FI:** Sammuta virta ennen kytkemistä



**NO:** Skadet glass må erstattes med nytt.  
**EN:** Damaged glass must be replaced.  
**DK:** Beskadiget glas skal udskiftes  
**SE:** Skadat glas måste ersättas med nytt.  
**FR:** Tout verre endommagé doit être remplacé.  
**NL:** Gebroken glas moet vervangen worden.  
**DE:** Glasscherben müssen ausgetauscht werden.  
**FI:** Vaurioitunut lasi on vaihdettava

**NORWAY**  
 SG Armaturen AS  
 Skytterheia 25  
 N-4790 Lillesand

**SWEDEN**  
 SG Armaturen AB  
 Tel: +46 31 81 71 10  
 info@sg-ab.se  
 www.sg-ab.se

**DENMARK**  
 SG Armaturen A/S  
 Tel: +45 70 70 72 13  
 info@sg-as.dk  
 www.sg-as.dk

**FRANCE**  
 SG Lighting SA/NV  
 Tel: +33(0) 4 94 93 00 00  
 info.france@sglighting.fr  
 www.sglighting.net

**GERMANY**  
 SG Leuchten GmbH  
 Tel: +49 40 23 99 44 59  
 info@sg-leuchten.de  
 www.sg-leuchten.de

Tel: +47 37 50 03 00  
 firmapost@sg-as.no  
 www.sg-as.no

**FINLAND**  
 SG Armaturen Oy  
 Tel: +358 02 07 30 39 60  
 info@sg-oy.fi  
 www.sg-oy.fi

**UNITED KINGDOM**  
 SG Lighting LTD  
 Tel: +47 37 50 03 00  
 info@sglighting.co.uk  
 www.sglighting.co.uk

**BENELUX**  
 SG Lighting SA/NV  
 Tel: +32(0) 15 20 72 71  
 info.benelux@sglighting.net  
 www.sglighting.net

**INTERNATIONAL**  
 SG Lighting Co Ltd.  
 Tel: +86 769 88 49 20 88  
 cindy@sgdgc.com  
 www.sg-as.com

Sensor

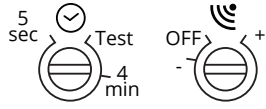
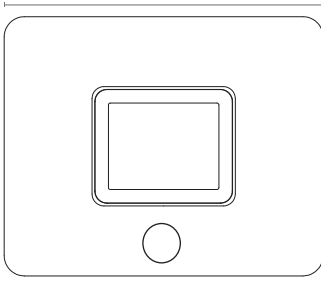

Sensor functions	
	Distance/range adjusting, 2-6m / Off
	Light time adjusting, 5sec-4min / Test =always on

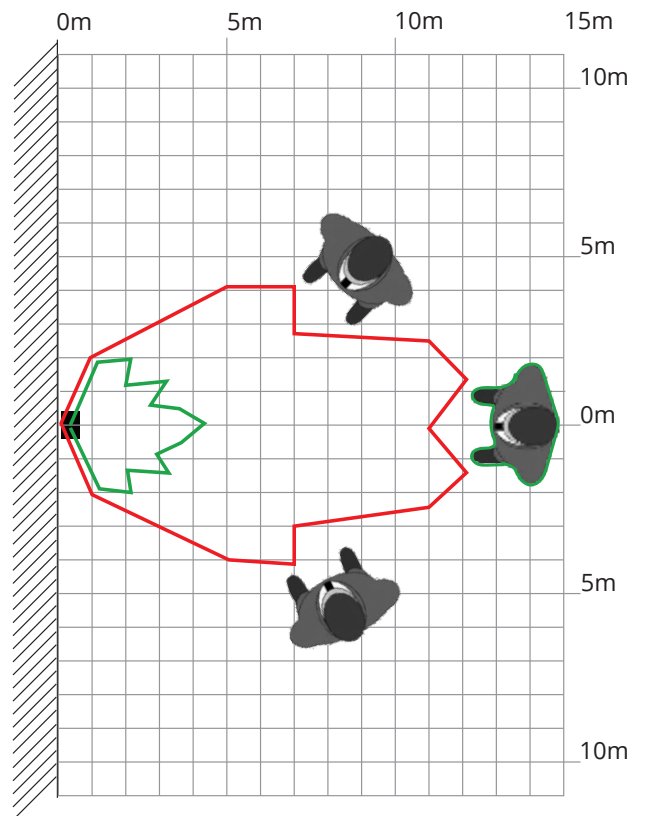
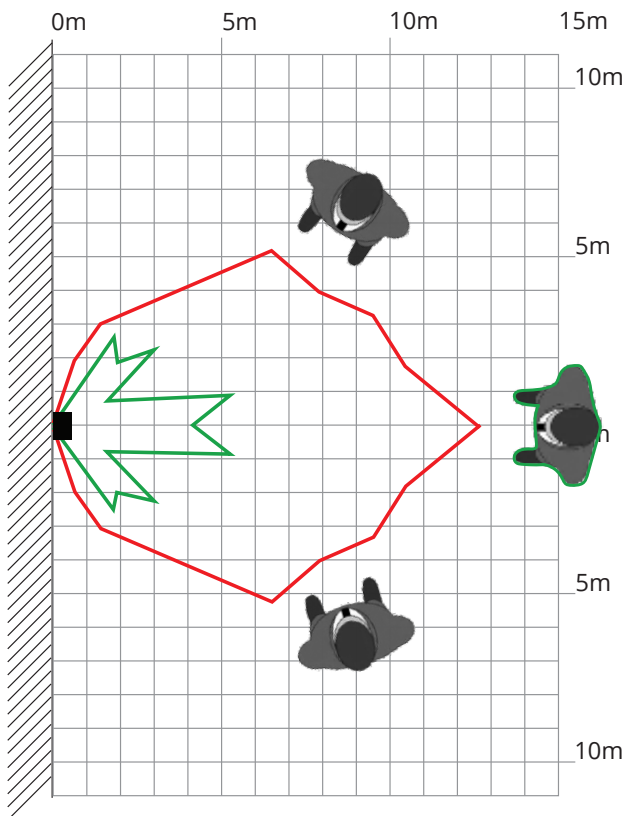
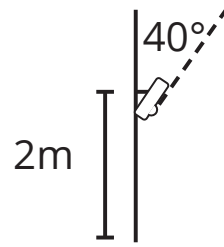
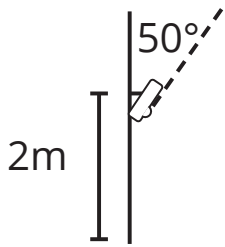
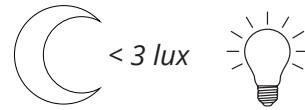
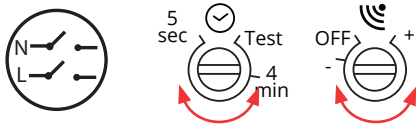
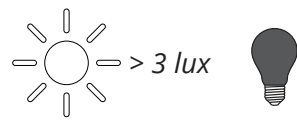

# Flom

CE UK CA IP65

220-240V, 50/60Hz

	Height	Width	Maximum projected area	Weight
Flom Mini	95mm	120mm	114cm <sup>2</sup>	0,54 kg
Flom Mini Sensor	95mm	120mm	114cm <sup>2</sup>	0,58 kg
Flom Midi	130mm	160mm	208cm <sup>2</sup>	0,91 kg
Flom Midi Sensor	130mm	160mm	208cm <sup>2</sup>	0,93 kg
Flom Maxi	160mm	200mm	320 cm <sup>2</sup>	1,47 kg
Flom Maxi Sensor	160mm	200mm	320 cm <sup>2</sup>	1,51 kg

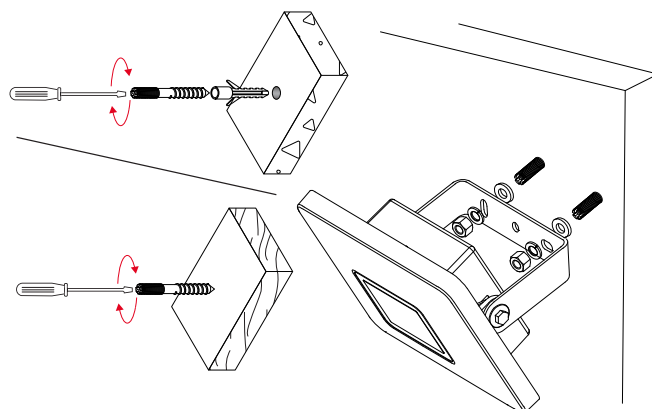
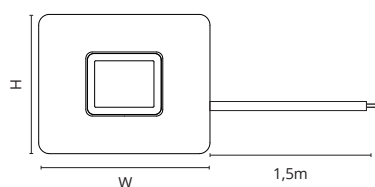

## Flom Mini

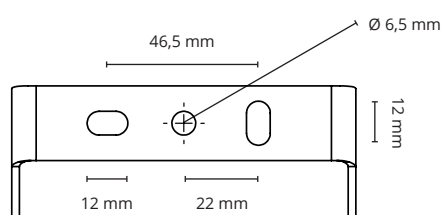

## Flom Midi

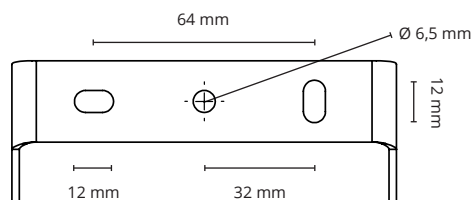

## Flom Maxi

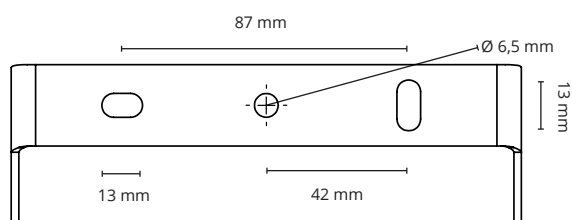

**NO:** Skru av strømmen før montering.

**EN:** Turn off power before installing.

**FR:** Couper le courant avant l'installation.

**NL:** Stroom uitschakelen voor u het toestel installeert.

**DE:** Vor Installationsarbeiten den Strom abschalten.

**FI:** Sammuuta virta ennen kytkemistä



**NO:** Skadet glass må erstattes med nytt.

**EN:** Replace any cracked protective shield.

**FR:** Tout verre endommagé doit être remplacé.

**NL:** Gebroken glas moet vervangen worden.

**DE:** Beschädigte Leuchten-Abdeckungen müssen ausgetauscht werden.

**FI:** Vaurioitunut lasi on vaihdettava



**NO:** Kan kun installeres og vedlikeholdes av en registrert installasjonsvirksomhet.

**EN:** Only to be installed and maintained by an authorized electrician.

**FR:** Doit être installé et maintenu par un électricien qualifié.

**NL:** Mag alleen geïnstalleerd en onderhouden worden door een bevoegde elektricien.

**DE:** Dieses Produkt darf nur durch autorisiertes Personal (z.B. Elektro-Installateur) angeschlossen, in Betrieb genommen und gewartet werden.

**FI:** Asentaa ja huoltaa saa vain valtuutettu sähköasentaja



**NO:** Lyskilden i denne armaturen er ikke utskiftbar. Når lyskildens levetid er omme skal hele armaturen byttes ut.

**EN:** The light source of this luminaire is not replaceable; when the light source reaches its end of life the whole luminaire shall be replaced.

**FR:** La source led de ce luminaire n'est pas remplaçable; lorsque cette source led atteint sa fin de vie, le luminaire complet doit être remplacé.

**NL:** De lichtbron van dit lichtarmatuur is niet vervangbaar; als deze lichtbron het einde van zijn levensduur bereikt zal het hele lichtarmatuur worden vervangen.

**DE:** Das Leuchtmittel dieser Leuchte ist nicht austauschbar. Wenn das Leuchtmittel das Ende der Lebensdauer erreicht hat, ist die gesamte Leuchte auszutauschen.

**FI:** Valonlähde ei vaihdettavissa; kun valonlähde on saavuttanut elinikänsä, koko valaisin tulee vaihtaa

### NORWAY

SG Armaturen AS

Skytterheia 25  
N-4790 Lillesand

Tel: +47 37 50 03 00  
firmapost@sg-as.no  
www.sg-as.no

### SWEDEN

SG Armaturen AB

Tel: +46 31 81 71 10  
info@sg-ab.se  
www.sg-ab.se

### FINLAND

SG Armaturen Oy  
Tel: +358 02 07 30 39 60  
info@sg-oy.fi  
www.sg-oy.fi

### DENMARK

SG Armaturen A/S

Tel: +45 70 70 72 13  
info@sg-as.dk  
www.sg-as.dk

### UNITED KINGDOM

SG Lighting LTD  
Tel: +47 37 50 03 00  
info@sighting.co.uk  
www.sighting.co.uk

### FRANCE

SG Lighting SA/NV

Tel: +33(0) 4 94 93 00 00  
info.france@sighting.fr  
www.sighting.net

### BENELUX

SG Lighting SA/NV  
Tel: +32(0) 15 20 72 71  
info.benelux@sighting.net  
www.sighting.net

### GERMANY

SG Leuchten GmbH

Tel: +49 40 23 99 44 59  
info@sg-leuchten.de  
www.sg-leuchten.de

### INTERNATIONAL

SG Lighting Co Ltd.  
Tel: +86 769 88 49 20 88  
cindy@sightedcn.com  
www.sg-as.com

Sensor

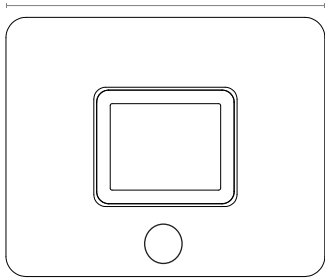

Sensor functions	
	Distance/range adjusting, 2-6m
	Light time adjusting, 5sec-5min

