

# Disc 285x285



220-240V, 50/60Hz

**NO:** Kan kun installeres og vedlikeholdes av en registrert installasjonsvirksomhet.  
**DK:** Må kun installeres og vedlikeholdes af uddannet elektriker.  
**SE:** Skall installeras och underhållas av behörig elektriker.  
**EN:** Only to be installed and maintained by an authorized electrician.  
**FR:** Doit être installé et maintenu par un électricien qualifié.  
**NL:** Mag alleen geïnstalleerd en onderhouden worden door een bevoegde elektricien.  
**DE:** Dieses Produkt darf nur durch autorisiertes Personal (z.B. Elektro-Installateur) angeschlossen, in Betrieb genommen und gewartet werden.  
**FI:** Asentaa ja huoltaa saa vain valtuutettu sähköasentaja

**NO:** Skru av strømmen før montering.  
**DK:** Sluk for strømmen inden montering.  
**SE:** Stäng av strømmen innan montering.  
**EN:** Turn off power before installing.  
**FR:** Couper le courant avant l'installation.  
**NL:** Stroom uitschakelen voor u het toestel installeert.  
**DE:** Vor Installationsarbeiten den Strom abschalten.  
**FI:** Sammuta virta ennen kytkemistä

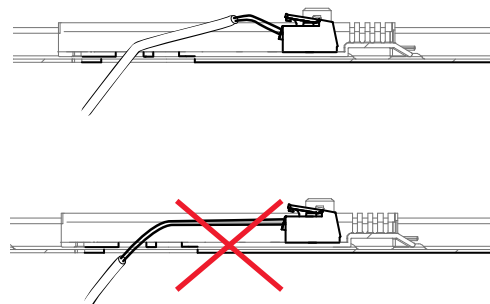
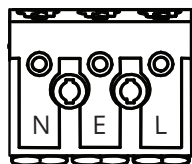
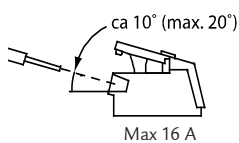
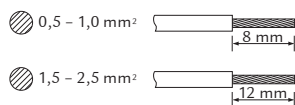
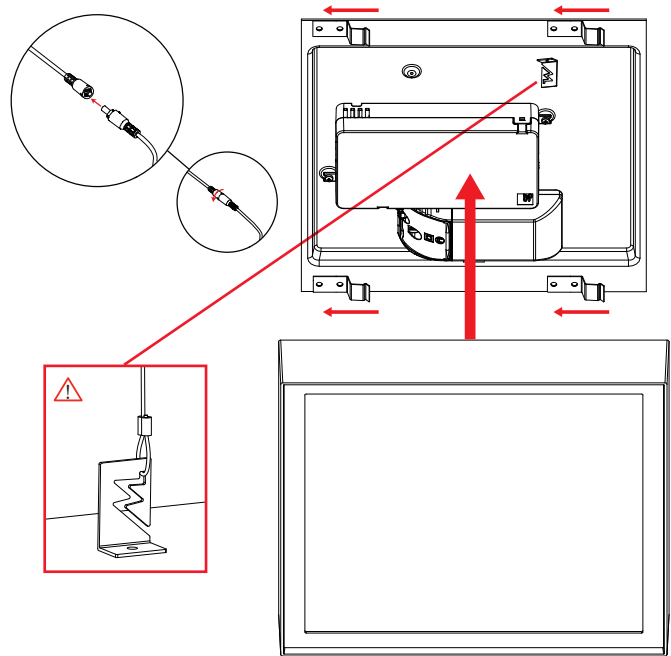
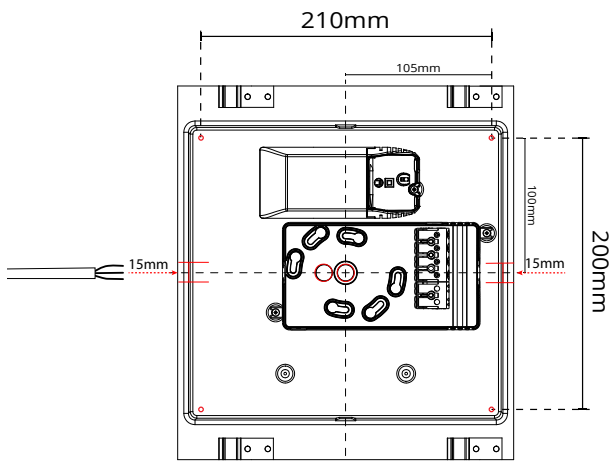

**NORWAY**  
SG Armaturen AS

Skytterheia 25  
N-4790 Lillesand

Tel: +47 37 50 03 00  
firmapost@sg-as.no  
www.sg-as.no

**SWEDEN**  
SG Armaturen AB  
Tel: +46 31 81 71 10  
info@sg-ab.se  
www.sg-ab.se

**FINLAND**  
SG Armaturen Oy  
Tel: +358 02 07 30 39 60  
info@sg-oy.fi  
www.sg-oy.fi

**DENMARK**  
SG Armaturen A/S  
Tel: +45 70 70 72 13  
info@sg-as.dk  
www.sg-as.dk

**UNITED KINGDOM**  
SG Lighting LTD  
Tel: +47 37 50 03 00  
info@sighting.co.uk  
www.sighting.co.uk

**FRANCE**  
SG Lighting SA/NV  
Tel: +33(0) 4 94 93 00 00  
info.france@sighting.fr  
www.sighting.net

**BENELUX**  
SG Lighting SA/NV  
Tel: +32(0) 15 20 72 71  
info.benelux@sighting.net  
www.sighting.net

**GERMANY**  
SG Leuchten GmbH  
Tel: +49 40 23 99 44 59  
info@sg-leuchten.de  
www.sg-leuchten.de

**INTERNATIONAL**  
SG Lighting Co Ltd.  
Tel: +86 769 88 49 20 88  
cindy@sightcn.com  
www.sg-as.com

# Dipswitch

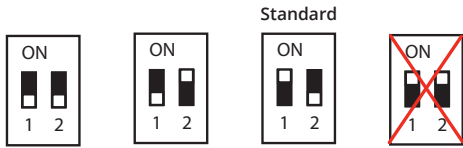

<b>mA</b>	500	600	<b>700</b>	800
<b>Im</b>	71%	86%	<b>100%</b>	-

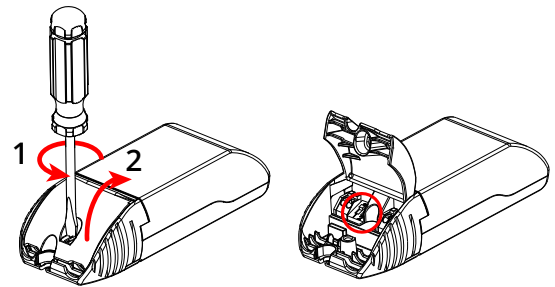

# Sensor Dim



NO: Max antall armaturer er begrenset av sikringen  
 DK: Det maksimale antal armaturer er begrænset af afbryderen  
 SE: Max antal armaturer begränsas av säkringen.  
 EN: Max number of fixtures is limited by the circuit breaker  
 FR: Le nombre maximum de montages est limité par le disjoncteur  
 NL: Max. aantal armaturen beperkt door de stroomonderbreker  
 DE: Die maximale Anzahl der Geräte ist abhängig vom eingesetzten Leitungsschutzschalter  
 FI: Valaisinten maksimimäärä määrytety sulakkeen koon mukaan

**Push**

**No Push**

		1	2
⌚	Hold time	10 minutes	1 1
		5 minutes	0 1
		1 minute	1 0
		5 seconds	0 0
📶	Motion sensitivity	High	1 1
		Medium	0 1
		Low	1 0
		Off	0 0
☀️	Daylight sensitivity	Low	<del>1 1</del>
		Medium	<del>0 1</del>
		High	<del>1 0</del>
		Off	0 0
🌙	Midnight cut	On	<del>1</del>
		Off	0
%	Basic light	On	1
		Off	0

**Hold time**

	1	2
10 min	1	1
5 min	0	1
1 min	1	0
5 sec	0	0

Rev: 09.11.2022

<p><b>NORWAY</b>                  SG Armaturen AS                  Skytterheia 25                  N-4790 Lillesand                  Tel: +47 37 50 03 00                  firmapost@sg-as.no                  www.sg-as.no</p>	<p><b>SWEDEN</b>                  SG Armaturen AB                  Tel: +46 31 81 71 10                  info@sg-ab.se                  www.sg-ab.se</p>	<p><b>DENMARK</b>                  SG Armaturen A/S                  Tel: +45 70 70 72 13                  info@sg-as.dk                  www.sg-as.dk</p>	<p><b>FRANCE</b>                  SG Lighting SA/NV                  Tel: +33(0) 4 94 93 00 00                  info.france@sglighting.fr                  www.sglighting.net</p>	<p><b>GERMANY</b>                  SG Leuchten GmbH                  Tel: +49 40 23 99 44 59                  info@sg-leuchten.de                  www.sg-leuchten.de</p>	<p><b>FINLAND</b>                  SG Armaturen Oy                  Tel: +358 02 07 30 39 60                  info@sg-oy.fi                  www.sg-oy.fi</p>	<p><b>UNITED KINGDOM</b>                  SG Lighting LTD                  Tel: +47 37 50 03 00                  info@sglighting.co.uk                  www.sglighting.co.uk</p>	<p><b>BENELUX</b>                  SG Lighting SA/NV                  Tel: +32(0) 15 20 72 71                  info.benelux@sglighting.net                  www.sglighting.net</p>	<p><b>INTERNATIONAL</b>                  SG Lighting Co Ltd.                  Tel: +86 769 88 49 20 88                  cindy@sgdgc.com                  www.sg-as.com</p>
---	--	--	---	---	---	--	--	--

### Motion sensitivity

	3	4
High	1	1
Medium	0	1
Low	1	0
Off	0	0

1

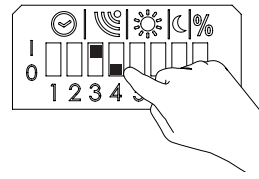

2

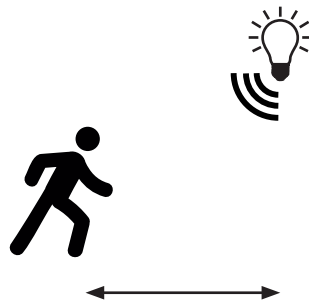
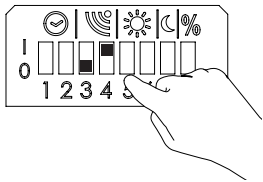

3

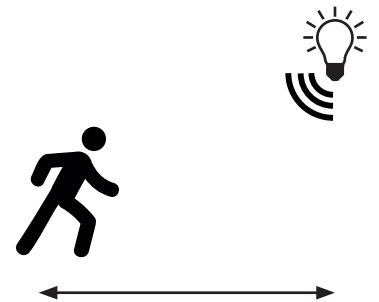
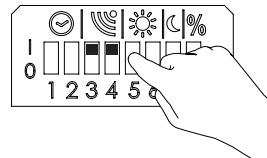

### Light levels - Basic light and max light

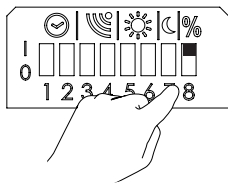

1

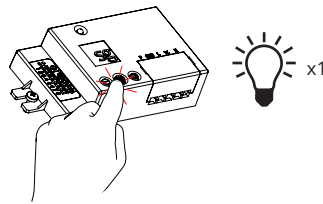

2

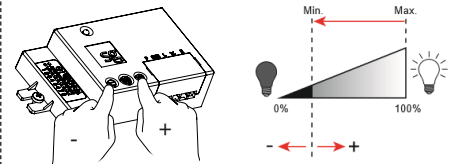

Basic light

3

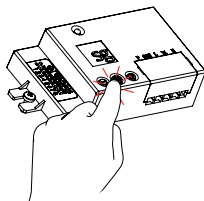

4

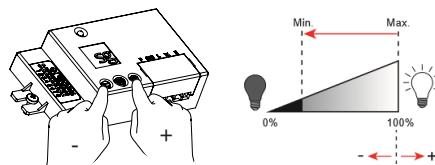

Maximum light level

5

