

# Frosta

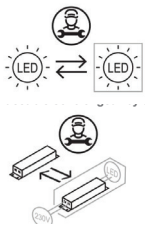

220-240V, 50/60Hz



**NO:** Kan kun installeres og vedlikeholdes av en registrert installasjonsvirksomhet.

**DK:** Må kun installeres og vedlikeholdes af uddannet elektriker.

**SE:** Skall installeras och underhållas av behörig elektriker.

**EN:** Only to be installed and maintained by an authorized electrician.

**FR:** Doit être installé et maintenu par un électricien qualifié.

**NL:** Mag alleen geïnstalleerd en onderhouden worden door een bevoegde electricien.

**DE:** Dieses Produkt darf nur durch autorisiertes Personal (z.B. Elektro-Installateur) angeschlossen, in Betrieb genommen und gewartet werden.

**FI:** Asentaa ja huolttaa saa vain valtuutettu sähköasentaja

**NO:** Skru av strømmen før montering.

**DK:** Sluk for strømmen inden montering.

**SE:** Stäng av strømmen innan montering.

**EN:** Turn off power before installing.

**FR:** Couper le courant avant l'installation.

**NL:** Stroom uitschakelen voor u het toestel installeert.

**DE:** Vor Installationsarbeiten den Strom abschalten.

**FI:** Sammuta virta ennen kytkemistä

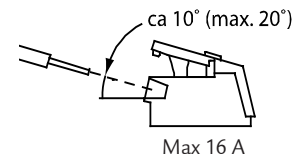
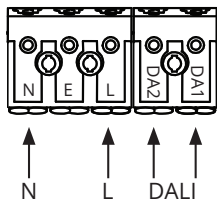
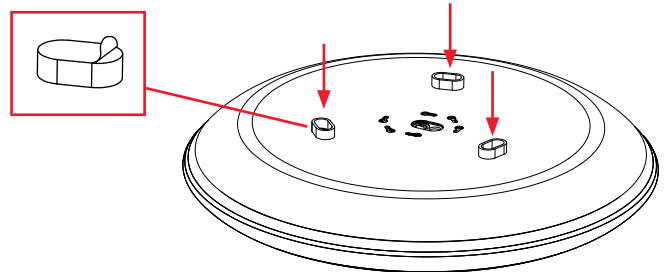
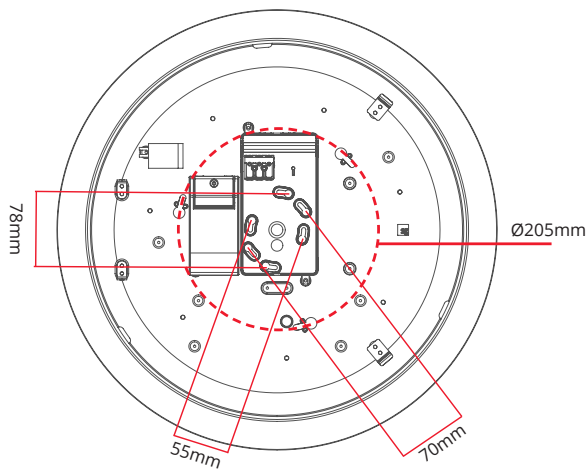
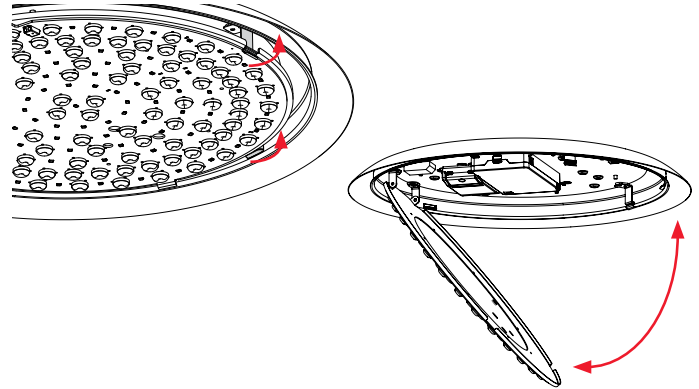
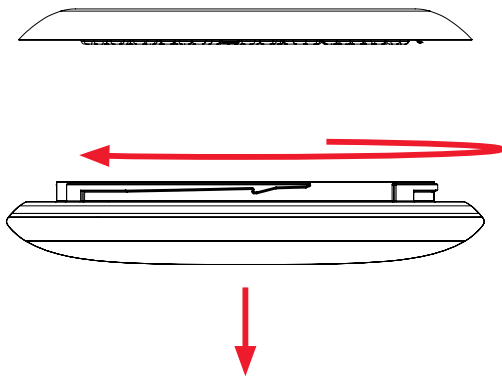

## NORWAY

SG Armaturen AS

Skytterheia 25  
N-4790 Lillesand

Tel: +47 37 50 03 00  
firmapost@sg-as.no  
www.sg-as.no

## SWEDEN

SG Armaturen AB  
Tel: +46 31 81 71 10  
info@sg-ab.se  
www.sg-ab.se

## FINLAND

SG Armaturen Oy  
Tel: +358 02 07 30 39 60  
info@sg-oy.fi  
www.sg-oy.fi

## DENMARK

SG Armaturen A/S  
Tel: +45 70 70 72 13  
info@sg-as.dk  
www.sg-as.dk

## UNITED KINGDOM

SG Lighting LTD  
Tel: +47 37 50 03 00  
info@sglighting.co.uk  
www.sglighting.co.uk

## FRANCE

SG Lighting SA/NV  
Tel: +33(0) 4 94 93 00 00  
info.france@sglighting.fr  
www.sglighting.net

## BENELUX

SG Lighting SA/NV  
Tel: +32(0) 15 20 72 71  
info.benelux@sglighting.net  
www.sglighting.net

## GERMANY

SG Leuchten GmbH  
Tel: +49 40 23 99 44 59  
info@sg-leuchten.de  
www.sg-leuchten.de

## INTERNATIONAL

SG Lighting Co Ltd.  
Tel: +86 769 88 49 20 88  
cindy@sgdgc.com  
www.sg-as.com

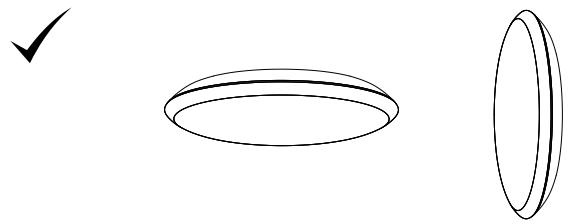
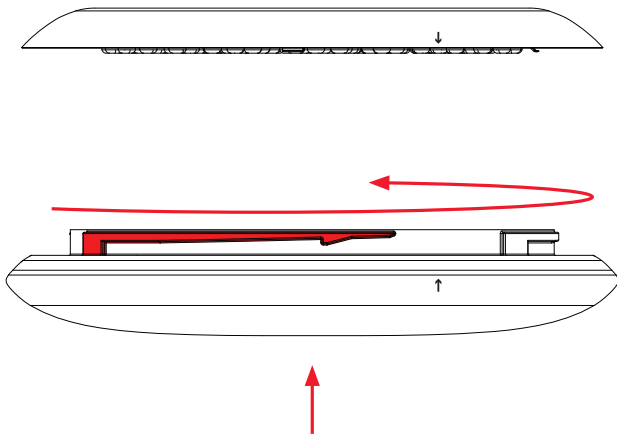

### Dipswitch

#### Frosta 480

#### Frosta 330

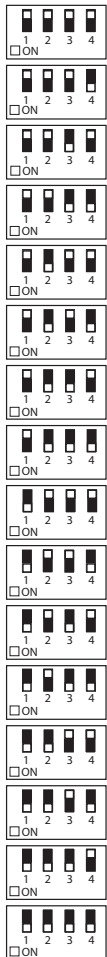

	mA	lm
ON	250	39%
ON	280	44%
ON	310	48%
ON	340	53%
ON	370	58%
ON	400	63%
ON	430	67%
ON	460	72%
ON	490	77%
ON	520	81%
ON	550	86%
ON	580	91%
ON	610	95%
ON	640	<b>100%</b>
OFF	<del>670</del>	<del></del>
OFF	<del>700</del>	<del></del>

	mA	lm
	125	36%
	150	43%
	175	50%
	200	57%
	225	64%
	250	71%
	275	79%
	300	86%
	325	93%
	<b>350</b>	<b>100%</b>
	<del>375</del>	<del></del>
	<del>400</del>	<del></del>
	<del>425</del>	<del></del>
	<del>450</del>	<del></del>
	<del>475</del>	<del></del>
	<del>500</del>	<del></del>

Standard

Standard

#### Dali Dim

#### Push Dim

