

# Circulus Maxi

**IP21**

220-240V, 50/60Hz, 30W

**1**

**2**

**3**

0,5 - 1,0 mm<sup>2</sup> → 8 mm  
 1,5 - 2,5 mm<sup>2</sup> → 12 mm

ca 10° (max. 20°)  
Max 16 A

**4**

**5**

**5**

**6**

**NO:** Kan kun installeres og vedlikeholdes av en registrert installasjonsvirksomhet.  
**DK:** Må kun installeres og vedligeholdes af uddannet elektriker.  
**SE:** Skall installeras och underhållas av behörig elektriker.  
**EN:** Only to be installed and maintained by an authorized electrician.  
**FR:** Doit être installé et maintenu par un électricien qualifié.  
**NL:** Mag alleen geïnstalleerd en onderhouden worden door een bevoegde electricien.  
**DE:** Dieses Produkt darf nur durch autorisiertes Personal (z.B. Elektro-Installateur) angeschlossen, in Betrieb genommen und gewartet werden.  
**FI:** Asentaa ja huolttaa saa vain valtuutettu sähköasentaja

**NO:** Skru av strømmen før montering.  
**DK:** Sluk for strømmen inden montering.  
**SE:** Stäng av strømmen innan montering.  
**EN:** Turn off power before installing.  
**FR:** Couper le courant avant l'installation.  
**NL:** Stroom uitschakelen voor u het toestel installeert.  
**DE:** Vor Installationsarbeiten den Strom abschalten.  
**FI:** Sammuta virta ennen kytkemistä

**Dipswitch**

	ON	ON	ON	Standard
	1	2	1	2
<b>mA</b>	500	600	700	<b>800</b>
<b>Im</b>	63%	75%	88%	<b>100%</b>

**NORWAY**  
SG Armaturen AS

Skytterheia 25  
N-4790 Lillesand

Tel: +47 37 50 03 00  
firmapost@sg-as.no  
www.sg-as.no

**SWEDEN**  
SG Armaturen AB  
Tel: +46 31 81 71 10  
info@sg-ab.se  
www.sg-ab.se

**FINLAND**  
SG Armaturen Oy  
info@sg-oy.fi  
www.sg-oy.fi

**DENMARK**  
SG Armaturen A/S  
Tel: +45 70 70 72 13  
info@sg-as.dk  
www.sg-as.dk

**UNITED KINGDOM**  
SG Lighting LTD  
Tel: +47 37 50 03 00  
info@sglighting.co.uk  
www.sglighting.co.uk

**FRANCE**  
SG Lighting SA/NV  
Tel: +33(0) 4 94 93 00 00  
info.france@sglighting.fr  
www.sglighting.net

**BENELUX**  
SG Lighting SA/NV  
Tel: +32(0) 15 20 72 71  
info.benelux@sglighting.net  
www.sglighting.net

**GERMANY**  
SG Leuchten GmbH  
Tel: +49 40 23 99 44 59  
info@sg-leuchten.de  
www.sg-leuchten.de

**INTERNATIONAL**  
SG Lighting Co Ltd.  
Tel: +86 769 88 49 20 88  
cindy@sgdgc.com  
www.sg-as.com

# ELP Emergency



3h: LDM90HOST + B084

1h: LDM90HOST/1HR + B068

220-240V, 50/60Hz, Self-test

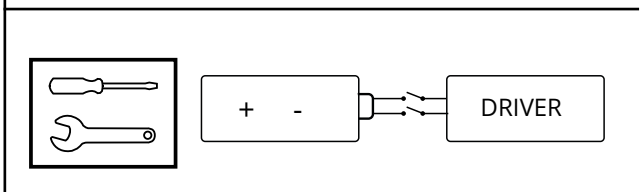
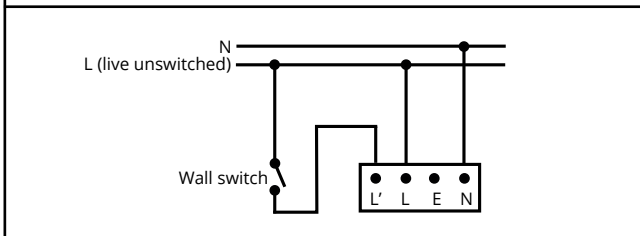
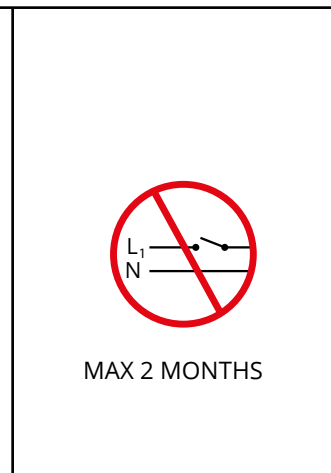
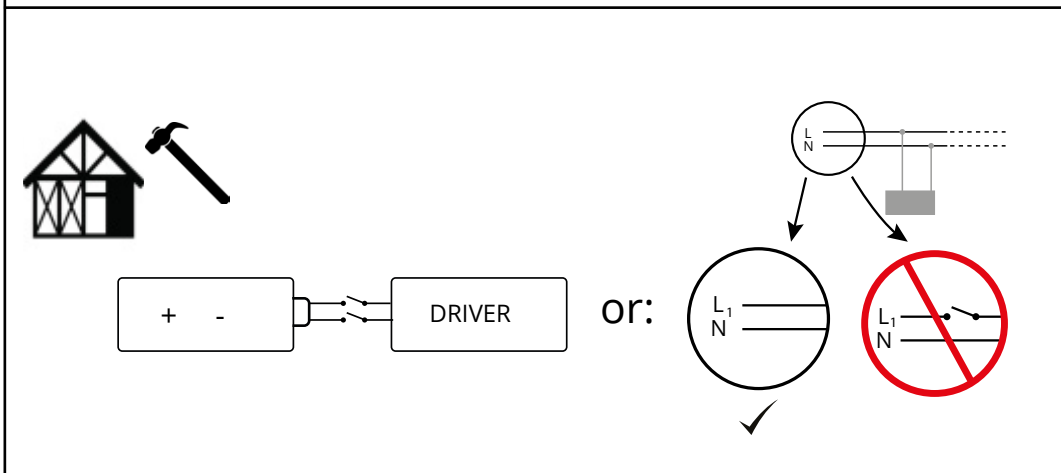
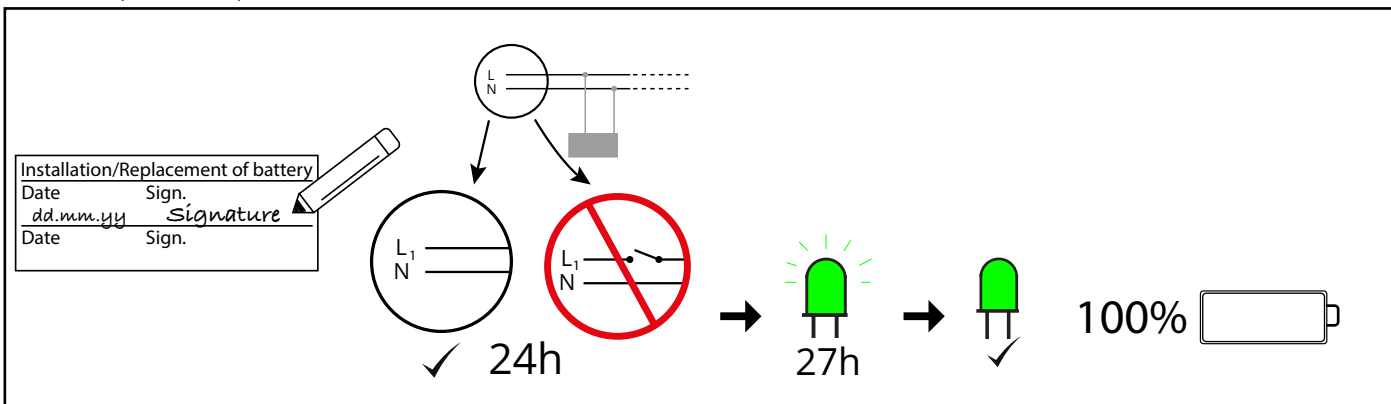

4-5 years Please also consider local requirements.

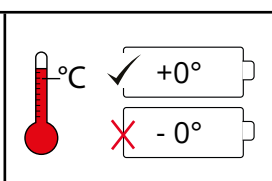

		System OK/main operation mode
	2 sec	Duration test/comissioning
	0,5 sec	Function test
		LED luminaire fault
	2 sec	Battery/test failure
	0,5 sec	Battery charging failure

**NORWAY** SG Armaturen AS  
Tlf:+47 37 50 03 00  
firmapost@sg-as.no  
www.sg-as.no

**SWEDEN** SG Armaturen AB  
Tel: +46 31 81 71 10  
info@sg-ab.se  
www.sg-ab.se

**FRANCE** SG Lighting SA/NV  
Tel: +33(0) 4 94 93 00 00  
info.france@sglighting.fr  
www.sglighting.net

**GERMANY** SG Leuchten GmbH  
Tel: +49 40 23 99 44 59  
info@sg-leuchten.de  
www.sg-leuchten.de

**DENMARK** SG Armaturen A/S  
Tel: +45 70 70 72 13  
info@sg-as.dk  
www.sg-as.dk

**FINLAND** SG Armaturen Oy  
info@sg-oy.fi  
www.sg-oy.fi

**BENELUX** SG Lighting SA/NV  
Tel: +32(0) 15 20 72 71  
info.benelux@sglighting.net  
www.sglighting.net

**INTERNATIONAL** SG Lighting Co Ltd.  
Tel: +86 769 88 49 20 88  
cindy@sgdgc.com  
www.sg-as.com

Rev: 29.05.2019



# ELP Emergency



3h: LDM90HOST + B084

1h: LDM90HOST/1HR + B068

220-240V, 50/60Hz, Self-test



Installation/Replacement of battery

Date Sign.

dd.mm.yy *Signature*

Date Sign.

24h

→

27h

→

100%

+ -

or:

MAX 2 MONTHS

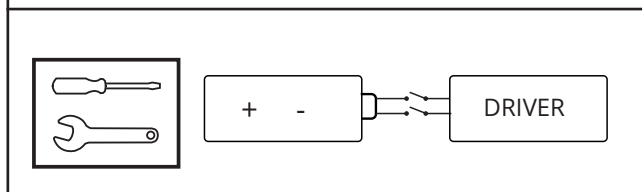
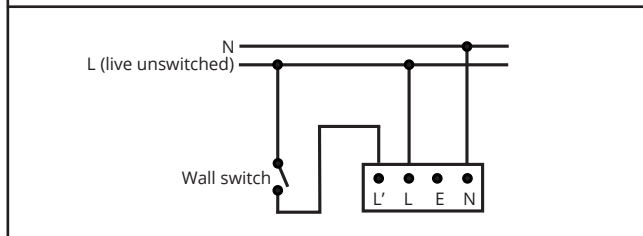

**3**  
YEARS  
BATTERY WARRANTY

4-5 years

°C

✓ +0°

✗ -0°

Please also consider local requirements.

		System OK/main operation mode
	2 sec	Duration test/comissioning
	0,5 sec	Function test
		LED luminaire fault
	2 sec	Battery/test failure
	0,5 sec	Battery charging failure

Rev: 28.06.2024

**NORWAY**  
SG Armaturen AS  
Skytterheia 25  
N-4790 Lillesand

**SWEDEN**  
SG Armaturen AB  
Tel: +46 31 81 71 10  
info@sg-ab.se  
www.sg-ab.se

**DENMARK**  
SG Armaturen A/S  
Tel: +45 70 70 72 13  
info@sg-as.dk  
www.sg-as.dk

**FRANCE**  
SG Lighting SA/NV  
Tel: +33(0) 4 94 93 00 00  
info.france@sglighting.fr  
www.sglighting.net

**GERMANY**  
SG Leuchten GmbH  
Tel: +49 40 23 99 44 59  
info@sg-leuchten.de  
www.sg-leuchten.de

Tel: +47 37 50 03 00  
firmapost@sg-as.no  
www.sg-as.no

**FINLAND**  
SG Armaturen Oy  
Tel: +358 02 07 30 39 60  
info@sg-oy.fi  
www.sg-oy.fi

**UNITED KINGDOM**  
SG Lighting LTD  
Tel: +47 37 50 03 00  
info@sglighting.co.uk  
www.sglighting.co.uk

**BENELUX**  
SG Lighting SA/NV  
Tel: +32(0) 15 20 72 71  
info.benelux@sglighting.net  
www.sglighting.net

**INTERNATIONAL**  
SG Lighting Co Ltd.  
Tel: +86 769 88 49 20 88  
cindy@sgdgc.com  
www.sg-as.com

