



Circulus





220-240V, 50/60Hz, 15W

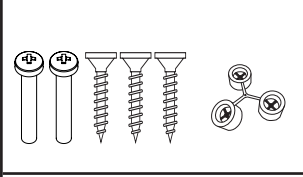
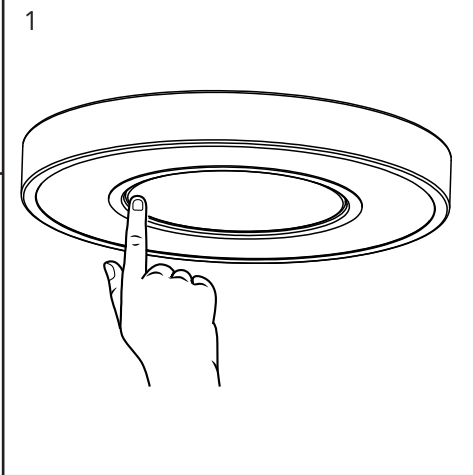
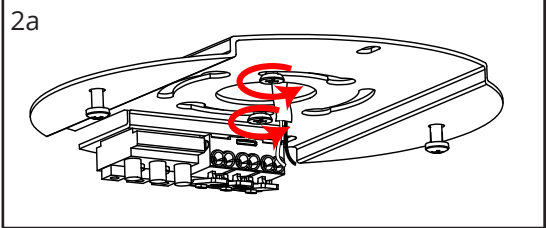
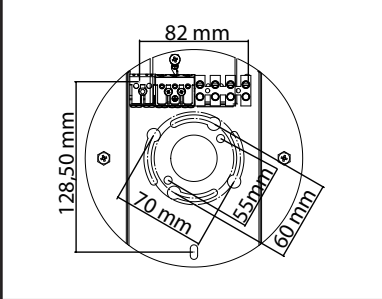
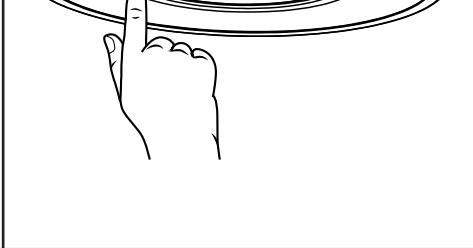
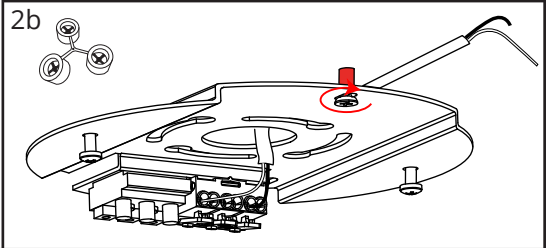
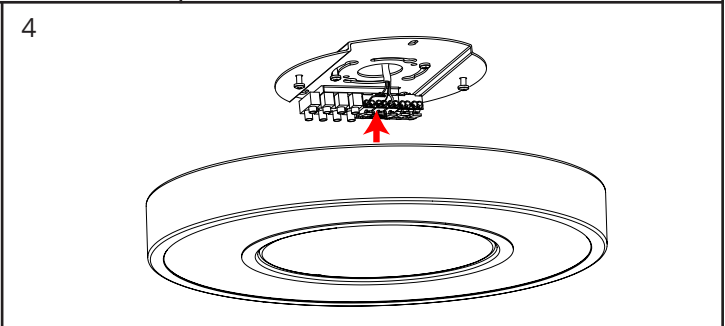
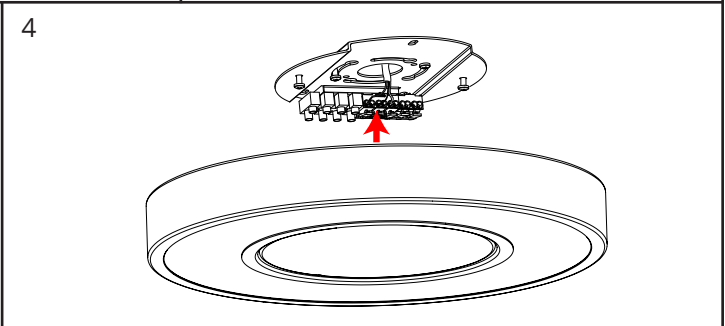
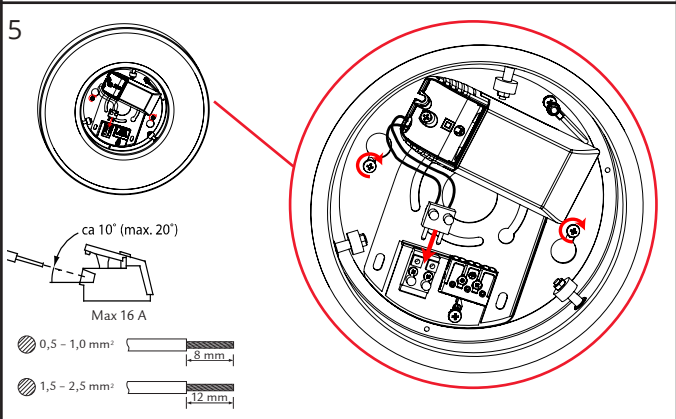

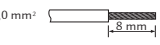
	<p>1</p> 	<p>2a</p> 	
		<p>2b</p> 	
<p>3</p> 	<p>4</p> 		
<p>5</p>  <p>ca 10° (max. 20°)</p> <p>Max 16 A</p> <p>  0,5 - 1,0 mm² 8 mm </p> <p>  1,5 - 2,5 mm² 12 mm </p>	<p>6</p> 		
<p> NO: Skru av strømmen før montering. DK: Sluk for strømmen inden montering. SE: Stäng av strømmen innan montering. EN: Turn off power before installing. FR: Couper le courant avant l'installation. NL: Stroom uitschakelen voor u het toestel installeert. DE: Vor Installationsarbeiten den Strom abschalten. FI: Sammuta virta ennen kytkemistä </p>			<p> NO: Kan kun installeres og vedlikeholdes av en registrert installasjonsvirksomhet. DK: Må kun installeres og vedligeholdes af uddannet elektriker. SE: Skall installeras och underhållas av behörig elektriker. EN: Only to be installed and maintained by an authorized electrician. FR: Doit être installé et maintenu par un électricien qualifié. NL: Mag alleen geïnstalleerd en onderhouden worden door een bevoegde elektricien. DE: Dieses Produkt darf nur durch autorisiertes Personal (z.B. Elektro-Installateur) angeschlossen, in Betrieb genommen und gewartet werden. FI: Asentaa ja huoltaa saa vain valtuutettu sähköasentaja </p>

NORWAY
SG Armaturen AS

Skytterheia 25
N-4790 Lillesand

Tel: +47 37 50 03 00
firmapost@sg-as.no
www.sg-as.no

SWEDEN
SG Armaturen AB
Tel: +46 31 81 71 10
info@sg-ab.se
www.sg-ab.se

FINLAND
SG Armaturen Oy
Tel: +358 02 07 30 39 60
info@sg-oy.fi
www.sg-oy.fi

DENMARK
SG Armaturen A/S
Tel: +45 70 70 72 13
info@sg-as.dk
www.sg-as.dk

UNITED KINGDOM
SG Lighting LTD
Tel: +47 37 50 03 00
info@sglighting.co.uk
www.sglighting.co.uk

FRANCE
SG Lighting SA/NV
Tel: +33(0) 4 94 93 00 00
info.france@sglighting.fr
www.sglighting.net

BENELUX
SG Lighting SA/NV
Tel: +32(0) 15 20 72 71
info.benelux@sglighting.net
www.sglighting.net

GERMANY
SG Leuchten GmbH
Tel: +49 40 23 99 44 59
info@sg-leuchten.de
www.sg-leuchten.de

INTERNATIONAL
SG Lighting Co Ltd.
Tel: +86 769 88 49 20 88
cindy@sgdgc.com
www.sg-as.com

Dipswitch

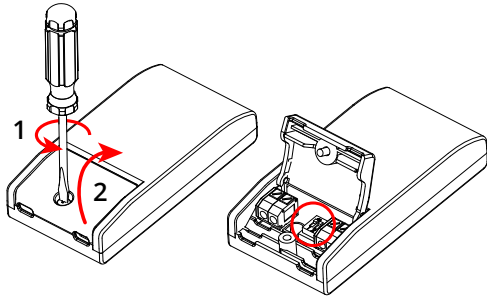

Standard

mA	200	250	300	350	400	450
Im	50%	63%	75%	88%	100%	113%