

Flom

220-240V, 50/60Hz

	Height	Width	Maximum projected area	Weight
Flom Mini	95mm	120mm	114cm ²	0,54 kg
Flom Mini Sensor	95mm	120mm	114cm ²	0,58 kg
Flom Midi	130mm	160mm	208cm ²	0,91 kg
Flom Midi Sensor	130mm	160mm	208cm ²	0,93 kg
Flom Maxi	160mm	200mm	320 cm ²	1,47 kg
Flom Maxi Sensor	160mm	200mm	320 cm ²	1,51 kg

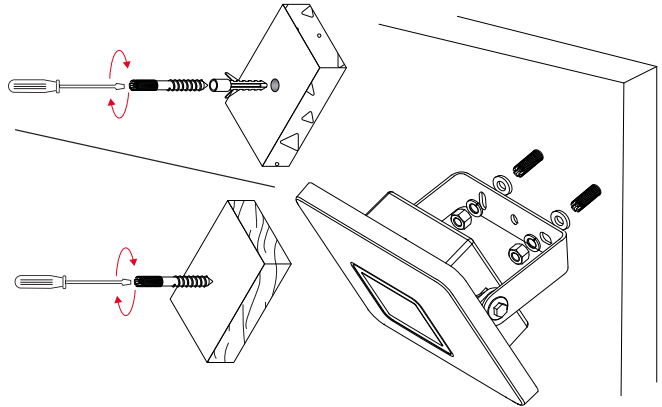
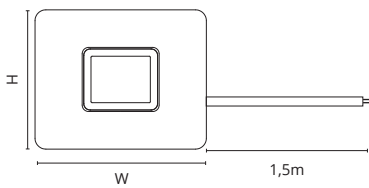

Flom Mini

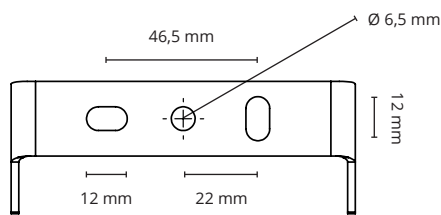

Flom Midi

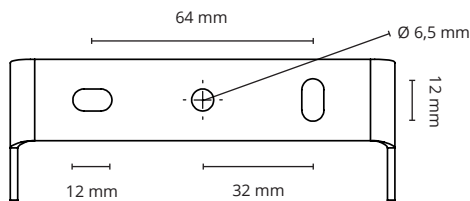

Flom Maxi

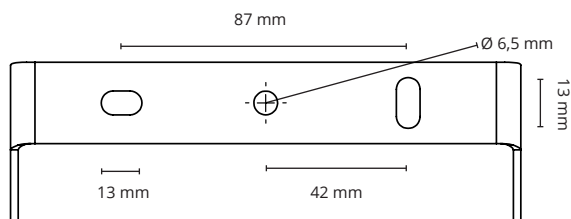

7: Non-replaceable light source



NO: Kan kun installeres og vedlikeholdes av en registrert installasjonsvirksomhet.
DK: Må kun installeres og vedlikeholdes af uddannet elektriker.
SE: Skall installeras och underhållas av behörig elektriker.
EN: Only to be installed and maintained by an authorized electrician.

3: Replaceable control gear by a professional

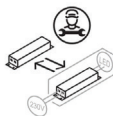

FR: Doit être installé et maintenu par un électricien qualifié.
NL: Mag alleen geïnstalleerd en onderhouden worden door een bevoegde elektricien.
DE: Dieses Produkt darf nur durch autorisiertes Personal (z.B. Elektro-Installateur) angeschlossen, in Betrieb genommen und gewartet werden.
FI: Asentaa ja huoltaa saa vain valtuutettu sähköasentaja



NO: Skru av strømmen før montering.
DK: Sluk for strømmen inden montering.
SE: Stäng av strømmen innan montering.
EN: Turn off power before installing.
FR: Couper le courant avant l'installation.
NL: Stroom uitschakelen voor u het toestel installeert.
DE: Vor Installationsarbeiten den Strom abschalten.
FI: Sammuta virta ennen kytkemistä



NO: Skadet glass må erstattes med nytt.
EN: Damaged glass must be replaced.
DK: Beskadiget glas skal udskiftes
SE: Skadat glas måste ersättas med nytt.
FR: Tout verre endommagé doit être remplacé.
NL: Gebroken glas moet vervangen worden.
DE: Glasscherben müssen ausgetauscht werden.
FI: Vaurioitunut lasi on vaihdettava

NORWAY
 SG Armaturen AS
 Skytterheia 25
 N-4790 Lillesand

SWEDEN
 SG Armaturen AB
 Tel: +46 31 81 71 10
 info@sg-ab.se
 www.sg-ab.se

DENMARK
 SG Armaturen A/S
 Tel: +45 70 70 72 13
 info@sg-as.dk
 www.sg-as.dk

FRANCE
 SG Lighting SA/NV
 Tel: +33(0) 4 94 93 00 00
 info.france@sglighting.fr
 www.sglighting.net

GERMANY
 SG Leuchten GmbH
 Tel: +49 40 23 99 44 59
 info@sg-leuchten.de
 www.sg-leuchten.de

Tel: +47 37 50 03 00
 firmapost@sg-as.no
 www.sg-as.no

FINLAND
 SG Armaturen Oy
 Tel: +358 02 07 30 39 60
 info@sg-oy.fi
 www.sg-oy.fi

UNITED KINGDOM
 SG Lighting LTD
 Tel: +47 37 50 03 00
 info@sglighting.co.uk
 www.sglighting.co.uk

BENELUX
 SG Lighting SA/NV
 Tel: +32(0) 15 20 72 71
 info.benelux@sglighting.net
 www.sglighting.net

INTERNATIONAL
 SG Lighting Co Ltd.
 Tel: +86 769 88 49 20 88
 cindy@sgdgc.com
 www.sg-as.com

Sensor

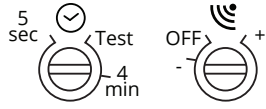
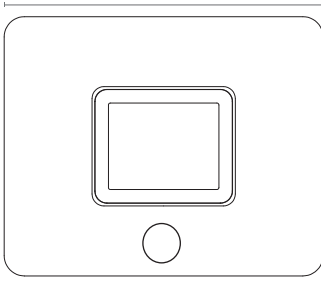

Sensor functions	
	Distance/range adjusting, 2-6m / Off
	Light time adjusting, 5sec-4min / Test =always on

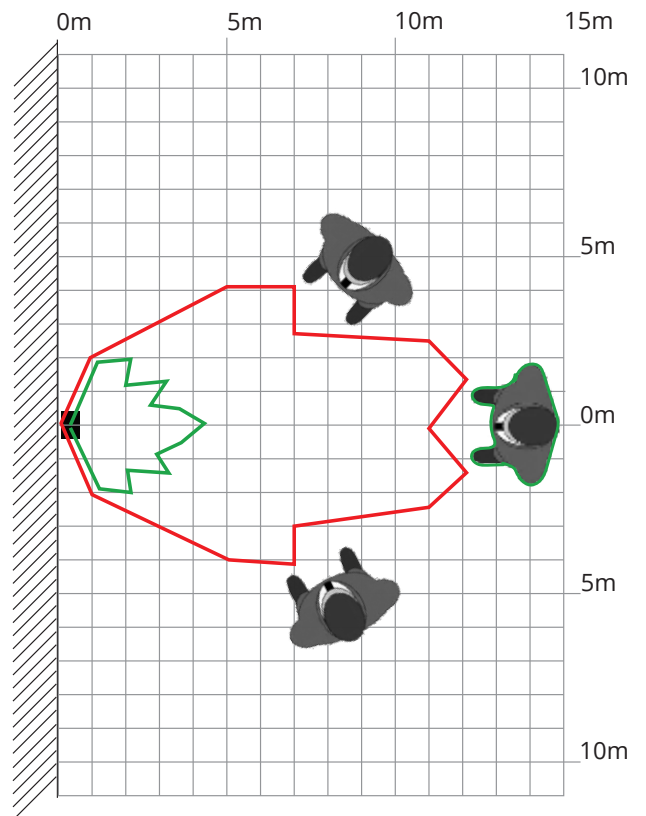
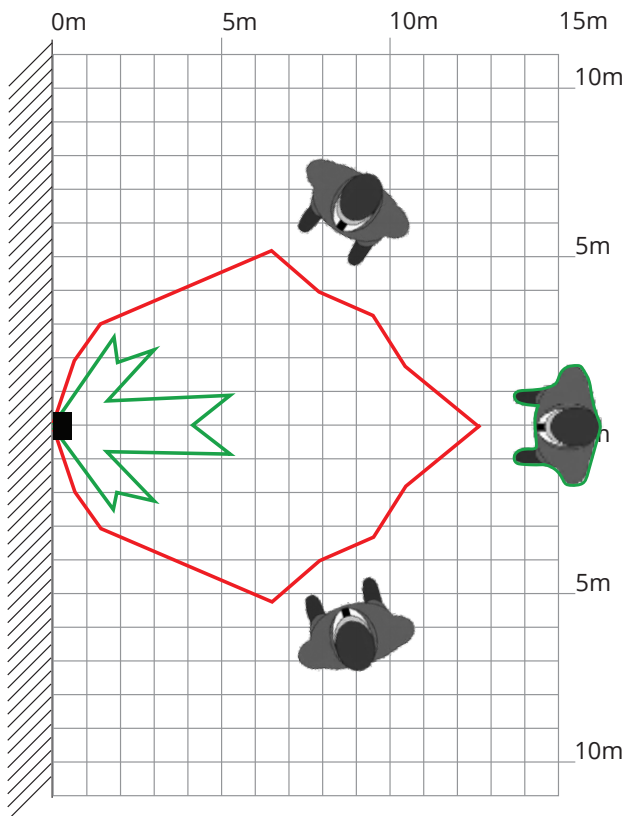
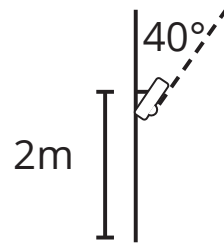
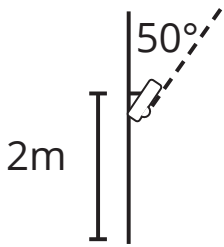
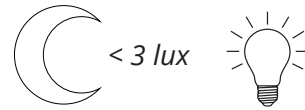
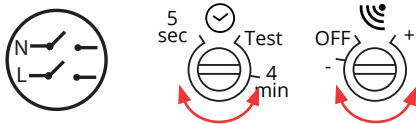
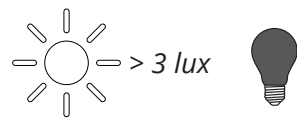

Flom

CE UK CA IP65

220-240V, 50/60Hz

	Height	Width	Maximum projected area	Weight
Flom Mini	95mm	120mm	114cm ²	0,54 kg
Flom Mini Sensor	95mm	120mm	114cm ²	0,58 kg
Flom Midi	130mm	160mm	208cm ²	0,91 kg
Flom Midi Sensor	130mm	160mm	208cm ²	0,93 kg
Flom Maxi	160mm	200mm	320 cm ²	1,47 kg
Flom Maxi Sensor	160mm	200mm	320 cm ²	1,51 kg

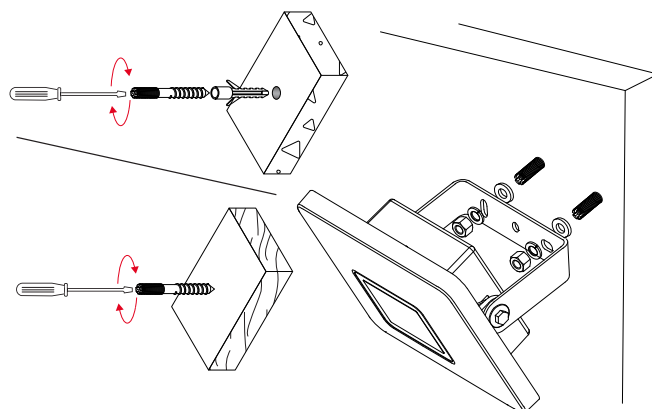
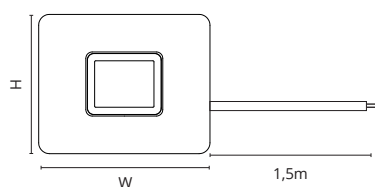

Flom Mini

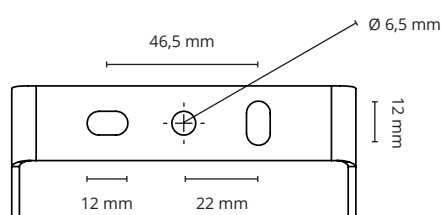

Flom Midi

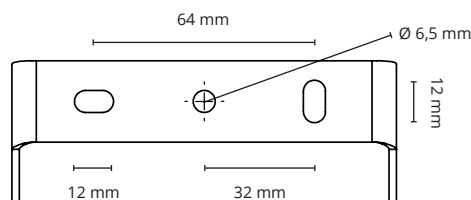

Flom Maxi

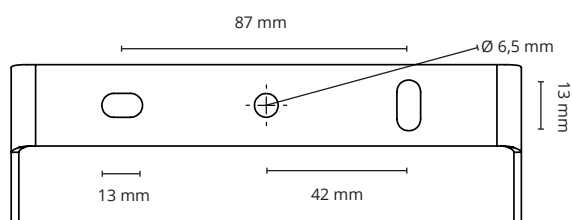

NO: Skru av strømmen før montering.

EN: Turn off power before installing.

FR: Couper le courant avant l'installation.

NL: Stroom uitschakelen voor u het toestel installeert.

DE: Vor Installationsarbeiten den Strom abschalten.

FI: Sammuuta virta ennen kytkemistä



NO: Skadet glass må erstattes med nytt.

EN: Replace any cracked protective shield.

FR: Tout verre endommagé doit être remplacé.

NL: Gebroken glas moet vervangen worden.

DE: Beschädigte Leuchten-Abdeckungen müssen ausgetauscht werden.

FI: Vaurioitunut lasi on vaihdettava



NO: Kan kun installeres og vedlikeholdes av en registrert installasjonsvirksomhet.

EN: Only to be installed and maintained by an authorized electrician.

FR: Doit être installé et maintenu par un électricien qualifié.

NL: Mag alleen geïnstalleerd en onderhouden worden door een bevoegde elektricien.

DE: Dieses Produkt darf nur durch autorisiertes Personal (z.B. Elektro-Installateur) angeschlossen, in Betrieb genommen und gewartet werden.

FI: Asentaa ja huoltaa saa vain valtuutettu sähköasentaja



NO: Lyskilden i denne armaturen er ikke utskiftbar. Når lyskildens levetid er omme skal hele armaturen byttes ut.

EN: The light source of this luminaire is not replaceable; when the light source reaches its end of life the whole luminaire shall be replaced.

FR: La source led de ce luminaire n'est pas remplaçable; lorsque cette source led atteint sa fin de vie, le luminaire complet doit être remplacé.

NL: De lichtbron van dit lichtarmatuur is niet vervangbaar; als deze lichtbron het einde van zijn levensduur bereikt zal het hele lichtarmatuur worden vervangen.

DE: Das Leuchtmittel dieser Leuchte ist nicht austauschbar. Wenn das Leuchtmittel das Ende der Lebensdauer erreicht hat, ist die gesamte Leuchte auszutauschen.

FI: Valonlähde ei vaihdettavissa; kun valonlähde on saavuttanut elinikänsä, koko valaisin tulee vaihtaa

NORWAY
SG Armaturen AS

Skytterheia 25
N-4790 Lillesand

Tel: +47 37 50 03 00
firmapost@sg-as.no
www.sg-as.no

SWEDEN
SG Armaturen AB
Tel: +46 31 81 71 10
info@sg-ab.se
www.sg-ab.se

FINLAND
SG Armaturen Oy
Tel: +358 02 07 30 39 60
info@sg-oy.fi
www.sg-oy.fi

DENMARK
SG Armaturen A/S
Tel: +45 70 70 72 13
info@sg-as.dk
www.sg-as.dk

UNITED KINGDOM
SG Lighting LTD
Tel: +47 37 50 03 00
info@sighting.co.uk
www.sighting.co.uk

FRANCE
SG Lighting SA/NV
Tel: +33(0) 4 94 93 00 00
info.france@sighting.fr
www.sighting.net

BENELUX
SG Lighting SA/NV
Tel: +32(0) 15 20 72 71
info.benelux@sighting.net
www.sighting.net

GERMANY
SG Leuchten GmbH
Tel: +49 40 23 99 44 59
info@sg-leuchten.de
www.sg-leuchten.de

INTERNATIONAL
SG Lighting Co Ltd.
Tel: +86 769 88 49 20 88
cindy@sightedcn.com
www.sg-as.com

Sensor

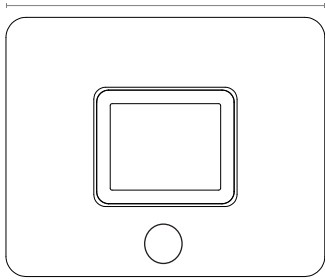

Sensor functions	
	Distance/range adjusting, 2-6m
	Light time adjusting, 5sec-5min

